



CD

CD08/0B-050C1

Connect.M8-F,4 poles-5m,PVC,90°

TECHNICAL FEATURES

Electrical data

Nominal current	Max. 4 A
Led	
Wires	4
Rated impulse voltage	0,8 kV
Nominal voltage	Max. 50Vac / 60Vdc

Mechanical data

Connections	
Tightening torque	0,6 Nm
Operating temperature	-10°C...+80°C (flexible installation) -25°C...+80°C (fixed installation)
Fibre length (m)	5

Head type	90°
Plug	M8
Outer diameter	Ø 4,7 mm ± 5%
Jacket material	PVC (CFC, cadmium, silicon, lead free) Flame retardant according to UL1581VW1/CSA FT1, self-extinguishing
Wire isolation	PVC (CFC, cadmium, silicon, lead free)
Bending radius	Wire for fixed installation: 5 x d Wire for flexible installation: 10 x d
Conductors section	0,25 mm ² (14 x 0,15 mm ²)
Model	

Test/Approvals

Degree of protection	IP67
----------------------	------

Generical Data

Operating Temperature	-10°C...+80°C (flexible installation) -25°C...+80°C (fixed installation)
Mechanical Protection	IP67

CONNECTIONS

Electrical diagram

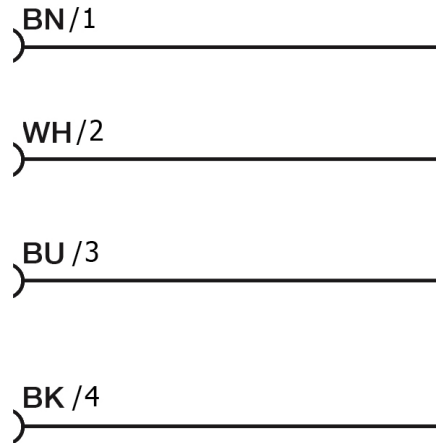

OTHERS

Dimensions

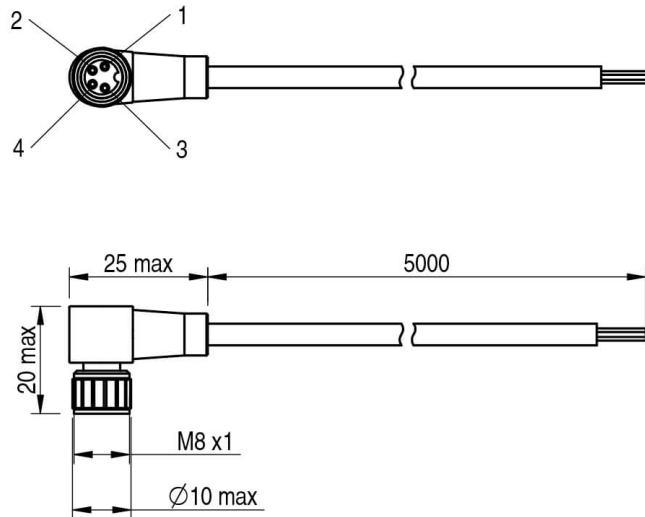

**Datasensing
S.r.l.**

Strada S.Caterina, 235
41122 Modena (MO)

**date of
printing**
15/06/2026
10:06:38

Tel. 059 420411
Fax 059 253973
E-mail
info@datasensing.com