



ST

ST 18-A7W

Bracket M18 axial AISI316L

TECHNICAL FEATURES

Application

Description

Stainless steel AISI316L (DIN 1.4404) axial mount bracket for M18 cylindrical sensors

Usable with

M18 cylindrical sensors

Installation

Mounting with M4 screws

Functions

M18 sensors

OTHERS

Dimensions

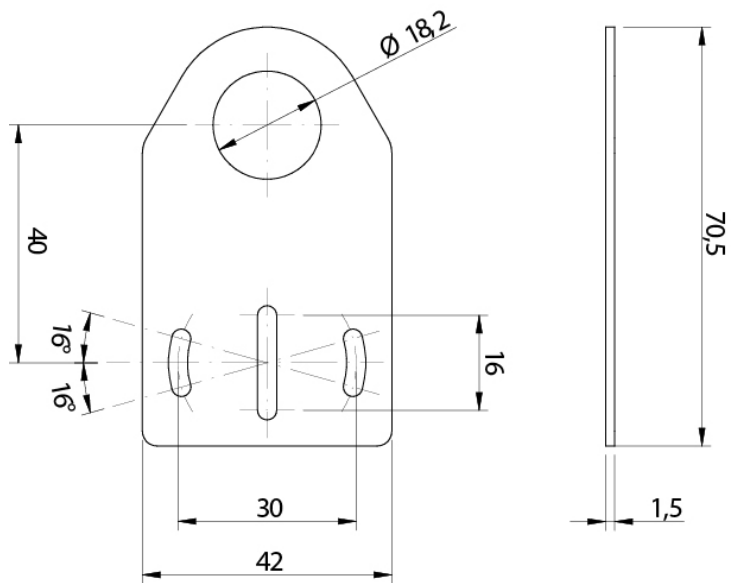

**Datasensing
S.r.l.**

Strada S.Caterina, 235
41122 Modena (MO)
Tel. 059 420411
Fax 059 253973
E-mail
info@datasensing.com

**date of
printing**
03/04/2026
00:43:28