



MS-MP

MS4/00-0E

Photo.M18,NPN/PNP-NO/NC,M12
plug,Diffuse

M18 DECOU[®] DC OUTPUT

OVERVIEW

- Wide range of models: diffuse, retro-reflective, polarized, through-beam detection and background suppression
- Through-beam models with high sensing range
- Retro-reflective models with red visible polarized light
- Models with right angle optic (MP)
- Background suppression models with fixed distance
- Check function available for all through-beam models
- Complete protection against electrical damage



TECHNICAL FEATURES

Detection properties

Nominal sensing distance	200mm
--------------------------	-------

Thermal drift of Sr	$\leq 10\%$ Sr
---------------------	----------------

Repeat Accuracy	5%
-----------------	----

Sensitivity adjustment	No
------------------------	----

Application

Function Principle	Diffuse reflection (short distance, $\leq 200\text{mm}$)
Notes	white target Kodak 90% 200 x 200mm
Optic position	Axial

Outputs

Output type	Decout NPN/PNP Selectable NO/NC Selectable
Output Function	NO/NC Selectable
Switching frequency	80Hz
Response time	6,25ms

Electrical data

Operating Voltage	10...30VDC
No-Load supply current	$\leq 40\text{mA}$
Load current	$\leq 100\text{mA}$
Leakage current	$\leq 10\mu\text{A}$
Output voltage drop	$\leq 1,2\text{V}@I_{\text{load}}=100\text{mA}$
Max ripple content	$\leq 10\%$
LED indicators	Red (status output)
Time delay before availability	$\leq 200\text{ms}$
Short-circuit protection	Short circuit (autoreset), Overvoltage

Emission	LED Infrared (880nm)
Interference to external light	3000lux (incandescent lamp), 10000lux (sunlight)
Impulsive Overvoltage Protection	Impulsive Overvoltage Protection

Mechanical data

Dimensions	M18 x 1 /L =93mm
Housing material	PBT / PC plug
Weight	30g
Connections	M12 plug
Active Head Material	PMMA
Tightening torque	1Nm
Operating temperature	25°C..+ 70° C (Without freeze)
Diameter/Dimension	M18

Test/Approvals

Approvals	CE cURus
EMC compatibility	EN 60947-5-2
Shocks and vibrations	Vibration IEC 60068-2-6 / Shock IEC 60068-2-27
Degree of protection	IP67

Accessories

--	--

Supplied Accessories

nuts M18 x 1

Generical Data

Dimensions

M18 x 1 / L =93mm

Operating Temperature

- 25°C...+ 70°C (Without freeze)

Mechanical Protection

IP67

CONNECTIONS

Eletrical diagram

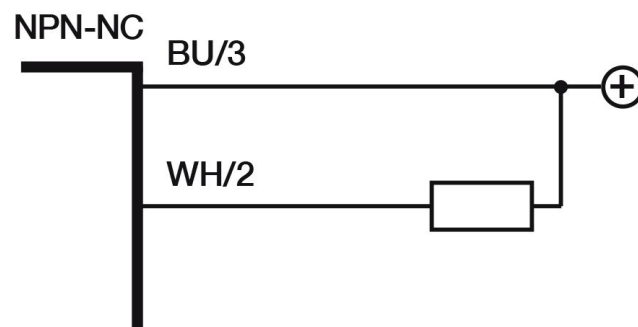
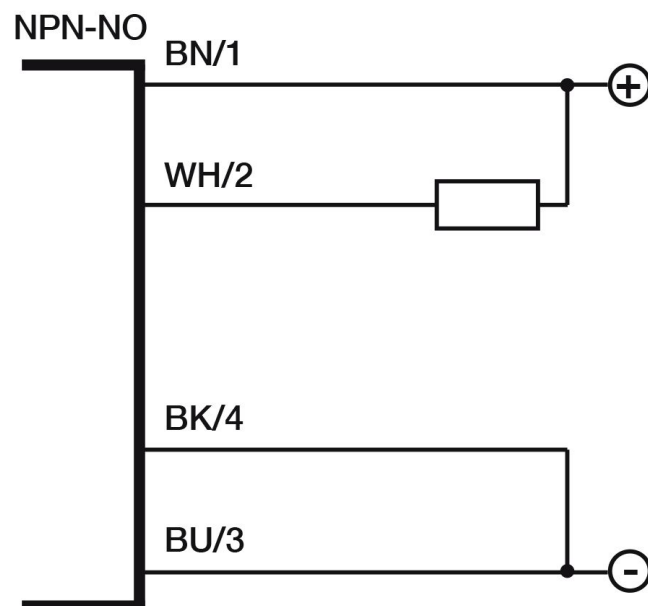

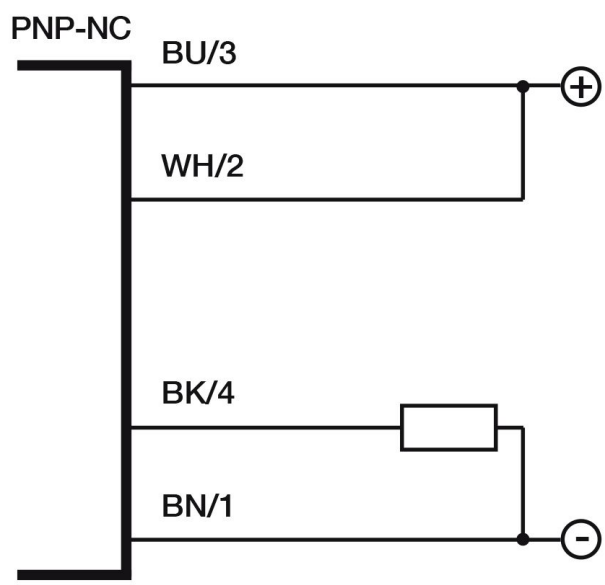
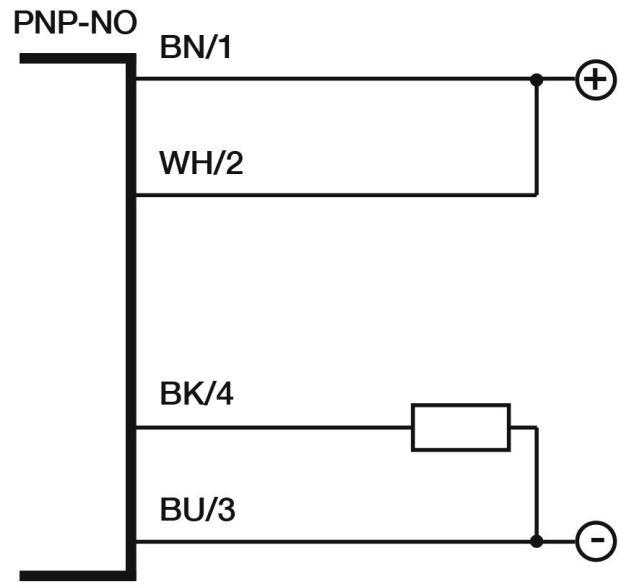
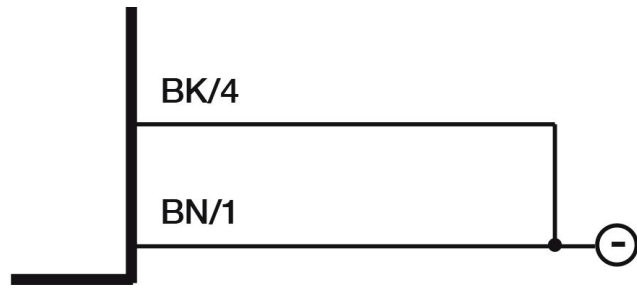

Connector

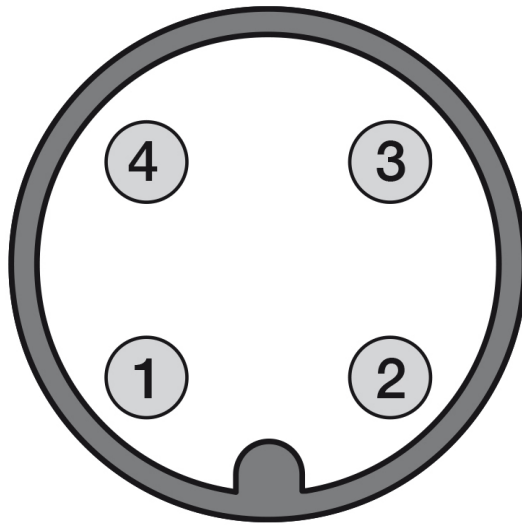

OTHERS

Dimensions

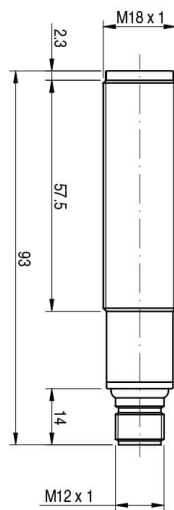
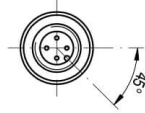

Response curves

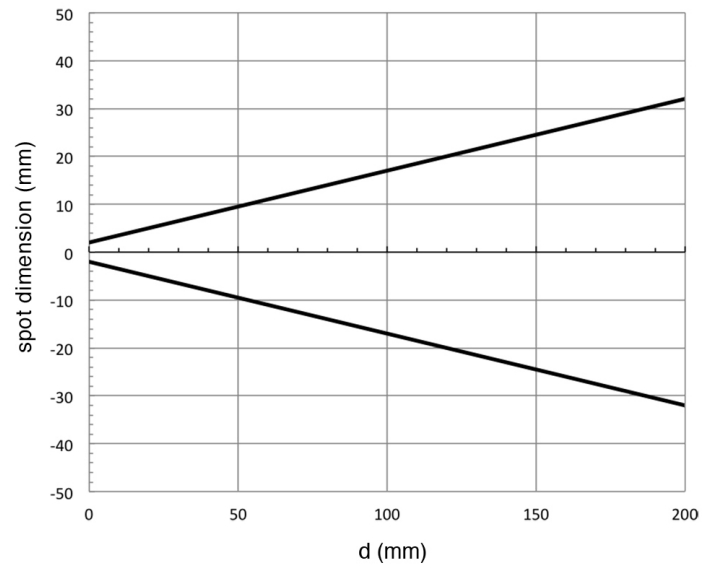

**Datasensing
S.r.l.**

Strada S.Caterina, 235
41122 Modena (MO)
Tel. 059 420411
Fax 059 253973
E-mail
info@datasensing.com

**date of
printing**
18/06/2026
23:45:01