



VK

VK2/A0-1H

Ind.M18,2 wires AC-NO,M12 plug,Sch-STD
CYLINDRICAL M18 IN AC INDUCTIVE SENSORS

OVERVIEW

- Output: cable and M12 plug cable exit
- Models with 2 wires
- IP 67 protection degree
- Multivoltage 20 ...253 Vac



TECHNICAL FEATURES

Detection properties

Nominal sensing distance	5mm
Operanting distance	0...4,05mm
Standard target	18x18mm FE360
Correction Factor	copper: 0,35 / aluminium: 0,40 / brass: 0,50 / stainless steel: 0,80
Thermal drift of Sr	< 10%
Repeat Accuracy	< 5% (UB 24V Ta=23°C ±5°C)

Hysteresis	1 ... 20%
------------	-----------

Application

Description	M18 standard flush mount
-------------	--------------------------

Functions	Proximity
-----------	-----------

Outputs

Output type	TRIAC
-------------	-------

Output Function	NO
-----------------	----

Switching frequency	25Hz
---------------------	------

Electrical data

Operating Voltage	20...250Vac/50...60Hz
-------------------	-----------------------

Load current	5...300mA
--------------	-----------

Leakage current	$\leq 1\text{mA RMS max}$
-----------------	---------------------------

Output voltage drop	See curves
---------------------	------------

Max ripple content	$\leq 10\%$
--------------------	-------------

LED indicators	Yellow LED output state
----------------	-------------------------

Time delay before availability	$\leq 200\text{ms}$
--------------------------------	---------------------

Inrush current	7A (Ton = 10ms)
----------------	-----------------

Mechanical data

Dimensions	M18 x 1 / L = 73,3mm
Mounting	Shielded
Material	Nickel-plated brass
Housing material	Nickel-plated brass
Weight	30g
Connections	M12 plug
Active Head Material	PBT
Tightening torque	25Nm
Operating temperature	-25°C...+70°C
Diameter/Dimension	M18

Test/Approvals

Approvals	CE UR
EMC compatibility	IEC 60947-5-2
Shocks and vibrations	Vibration IEC 60068-2-6 / Shock IEC 60068-2-27
Degree of protection	IP67

Accessories

Supplied Accessories	2 nuts M18x1
----------------------	--------------

Generical Data

Dimensions	M18 x 1 / L = 73,3mm
------------	----------------------

Operating Temperature	-25°C...+70°C
Mechanical Protection	IP67

CONNECTIONS

Electrical diagram

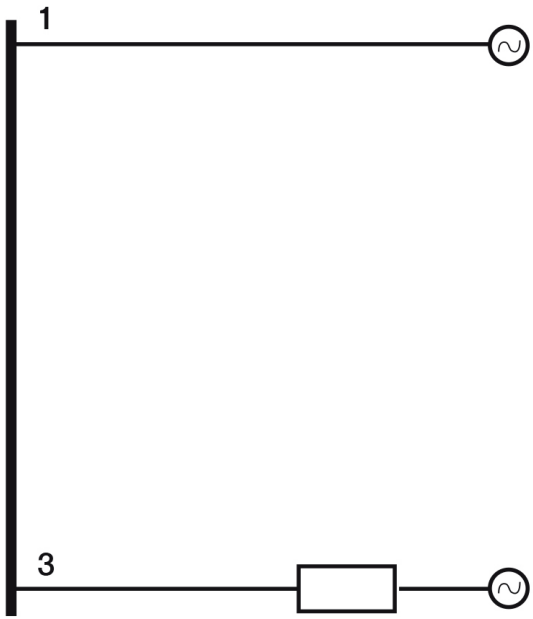
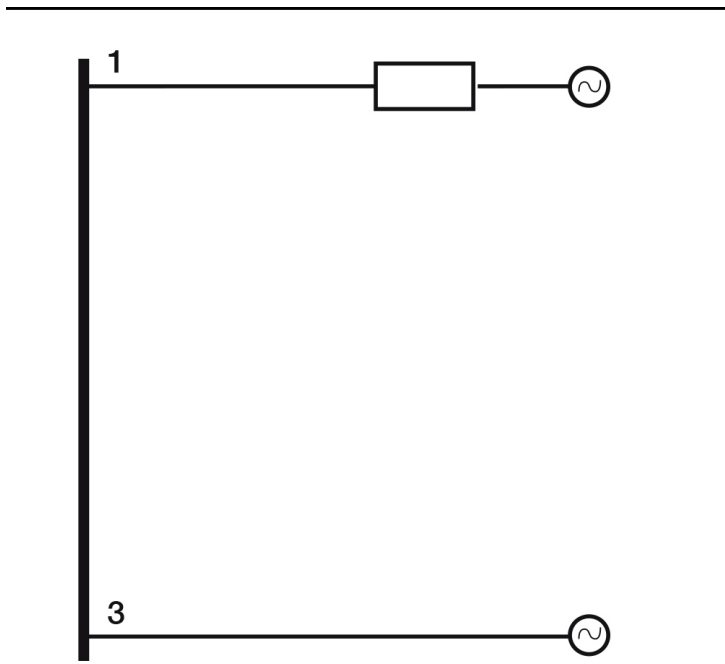

Connector

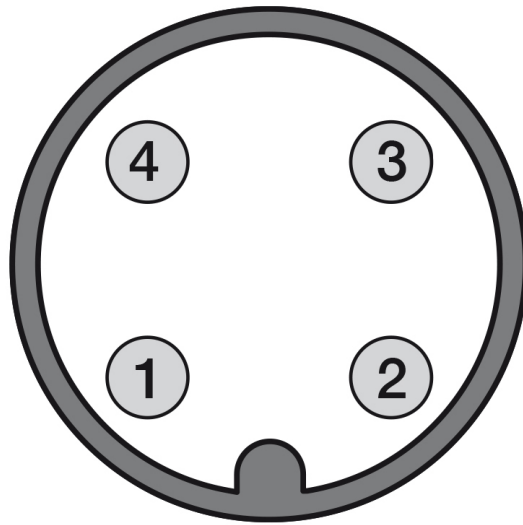

OTHERS

Dimensions

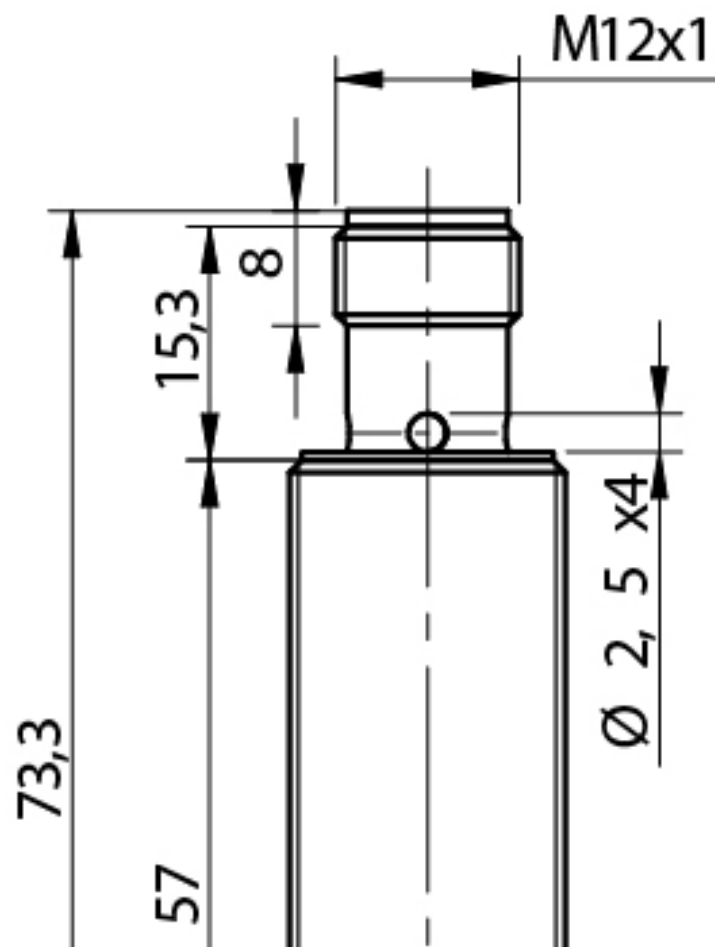

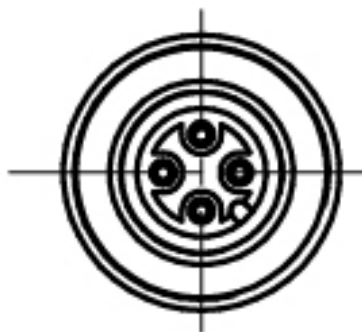
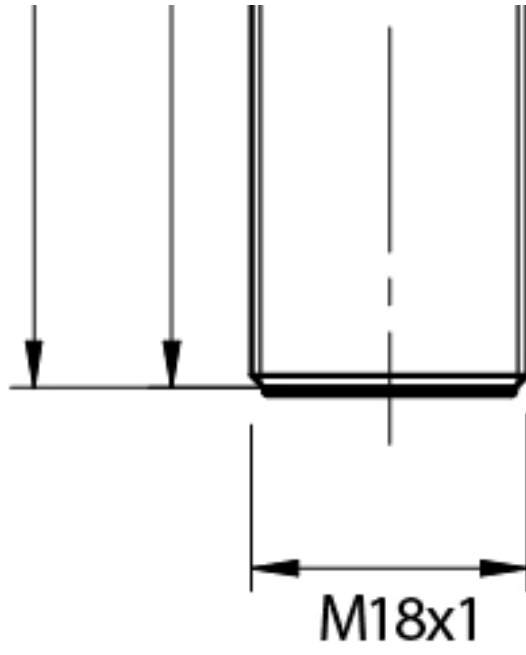

Response curves

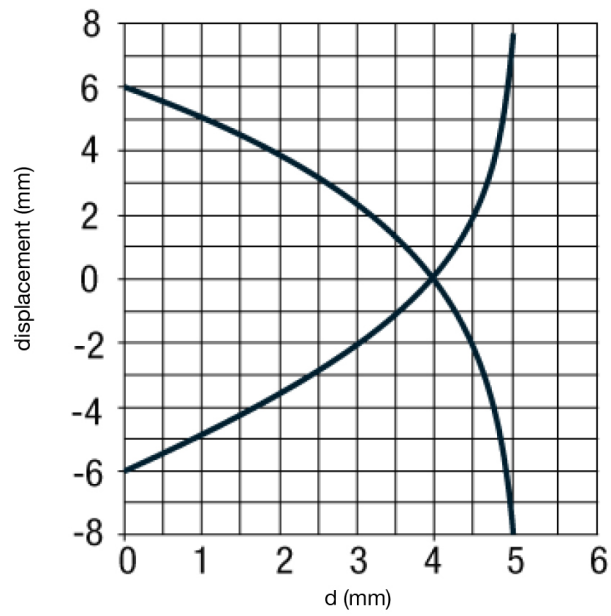

Installation

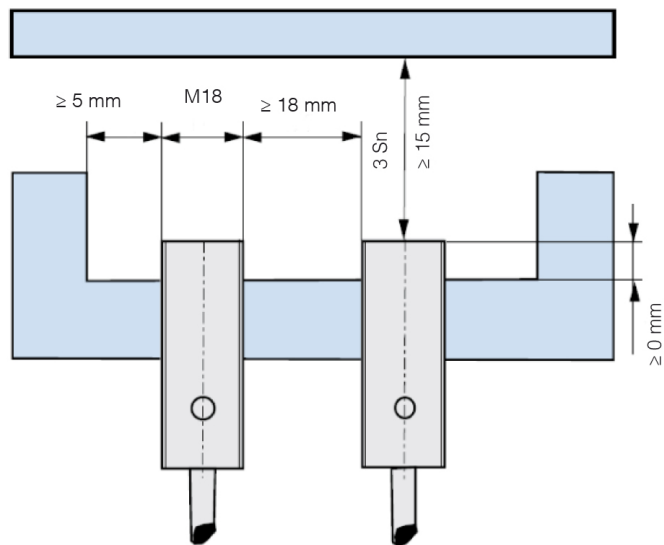

**Datasensing
S.r.l.**

Strada S.Caterina, 235
41122 Modena (MO)
Tel. 059 420411
Fax 059 253973
E-mail
info@datasensing.com

**date of
printing**
19/06/2026
03:40:14