



# VM

## VM2/C0-2H

Ind.M12,2 wires AC-NC,M12  
Plug,Nsch-STD

CYLINDRICAL M12 IN AC INDUCTIVE SENSORS

## OVERVIEW

- Output: cable and M12 plug cable exit
- Models with 2 wires
- IP67 protection degree
- Multivoltage 20 ...253 Vac



## TECHNICAL FEATURES

### Detection properties

Nominal sensing distance	4mm
Operanting distance	0...3,2mm
Standard target	12x12mm FE360
Correction Factor	copper: 0,45 / aluminium: 0,50 / brass: 0,60 / stainless steel: 0,80
Thermal drift of Sr	< 10%
Repeat Accuracy	< 5% (UB 24V Ta=23°C ±5°C)

Hysteresis	1 ... 20%
------------	-----------

## Application

Description	M12 standard no-flush mount
-------------	-----------------------------

Functions	Proximity
-----------	-----------

## Outputs

Output type	TRIAC
-------------	-------

Output Function	NC
-----------------	----

Switching frequency	25Hz
---------------------	------

## Electrical data

Operating Voltage	20...250Vac/50...60Hz
-------------------	-----------------------

Load current	5...300mA
--------------	-----------

Leakage current	$\leq 1\text{mA RMS max}$
-----------------	---------------------------

Output voltage drop	See curves
---------------------	------------

Max ripple content	$\leq 10\%$
--------------------	-------------

LED indicators	Yellow LED output state
----------------	-------------------------

Time delay before availability	$\leq 200\text{ms}$
--------------------------------	---------------------

Inrush current	7A (Ton = 10ms)
----------------	-----------------

## Mechanical data

Dimensions	M12 x 1 / L = 64mm
Mounting	Unshielded
Material	Nickel-plated brass
Housing material	Nickel-plated brass
Weight	30g
Connections	M12 plug
Active Head Material	PBT
Tightening torque	10Nm
Operating temperature	-25°C...+70°C
Diameter/Dimension	M12

#### Test/Approvals

Approvals	CE UR
EMC compatibility	IEC 60947-5-2
Shocks and vibrations	Vibration IEC 60068-2-6 / Shock IEC 60068-2-27
Degree of protection	IP67

#### Accessories

Supplied Accessories	2 nuts M12x1
----------------------	--------------

#### Generical Data

Dimensions	M12 x 1 / L = 64mm
------------	--------------------

Operating Temperature	-25°C...+70°C
Mechanical Protection	IP67

## CONNECTIONS

Electrical diagram

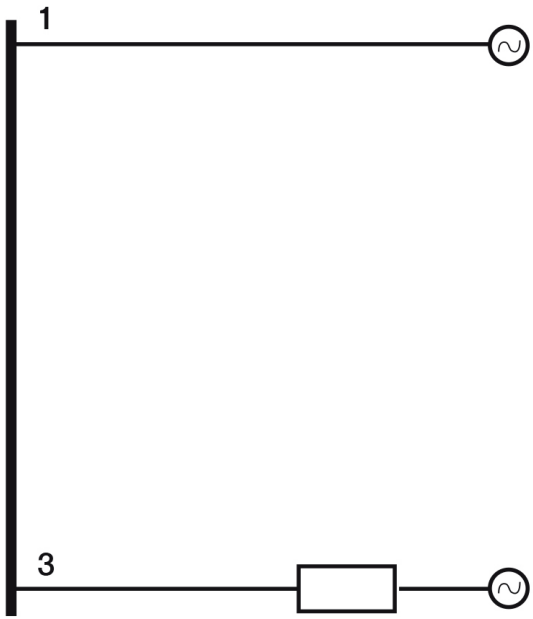
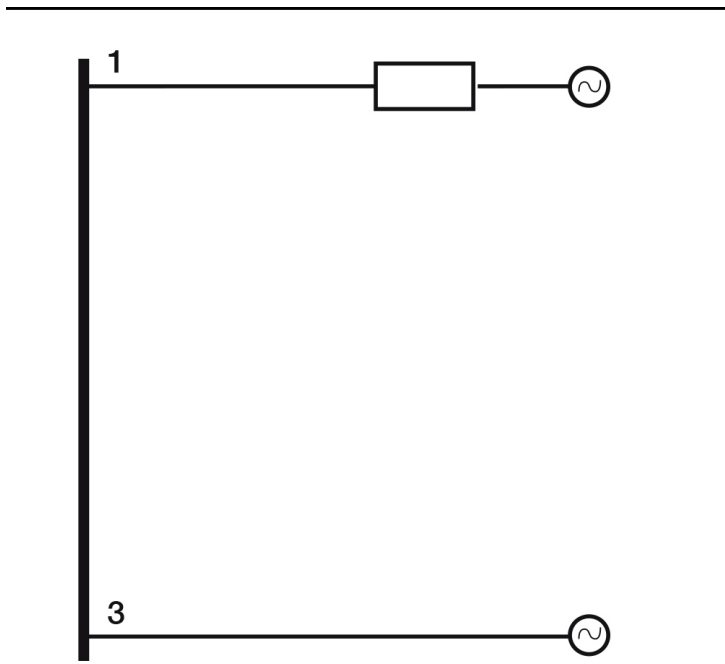

Connector

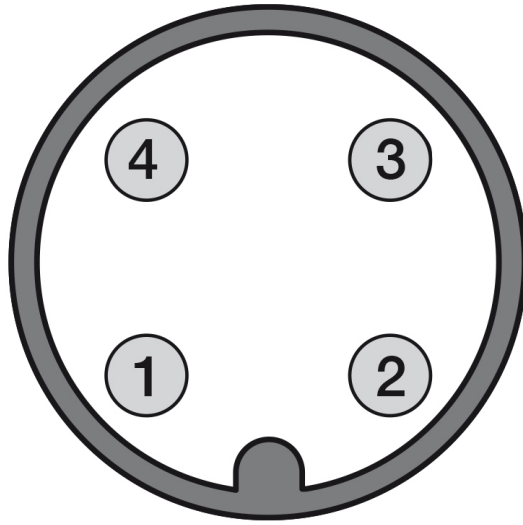

# OTHERS

Dimensions

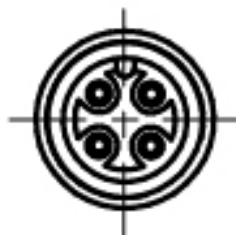
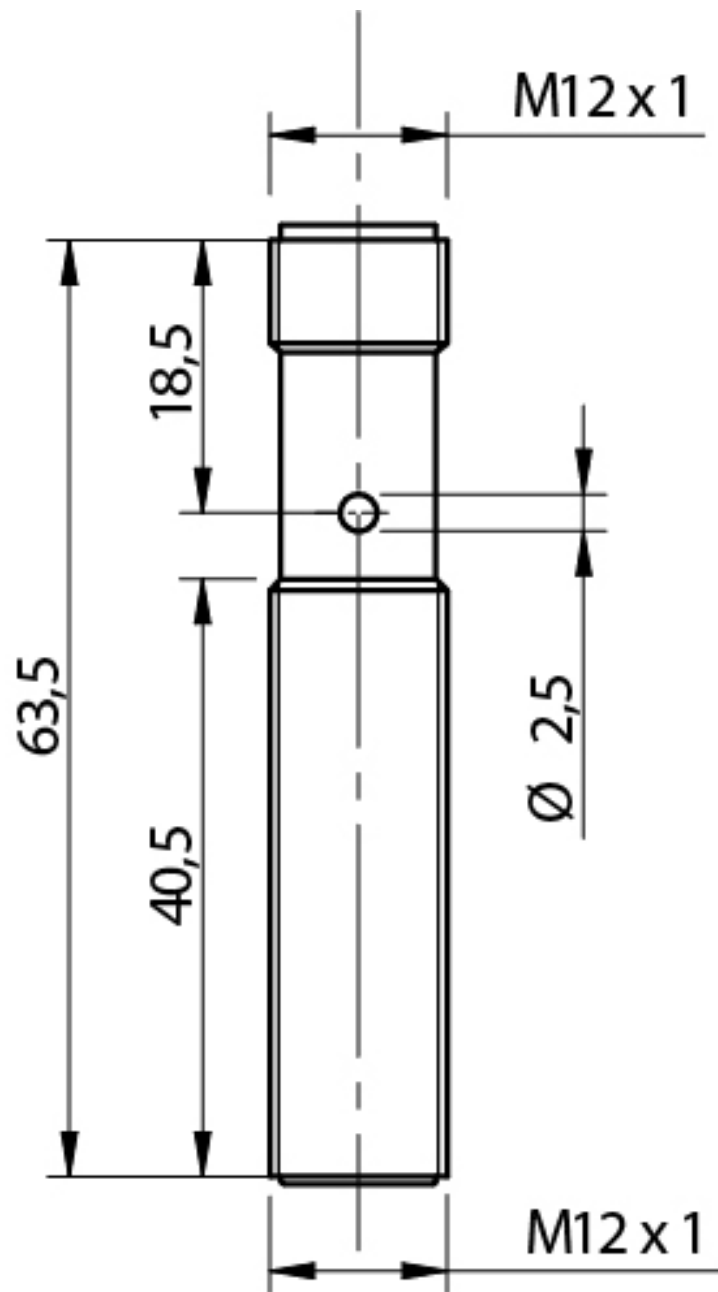

Response curves

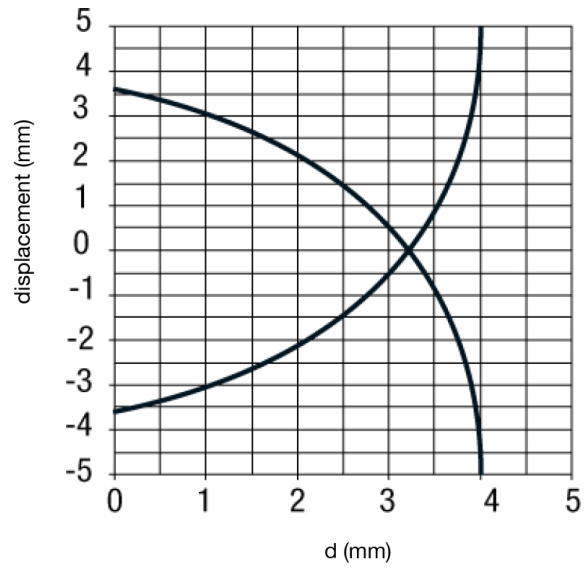

Installation

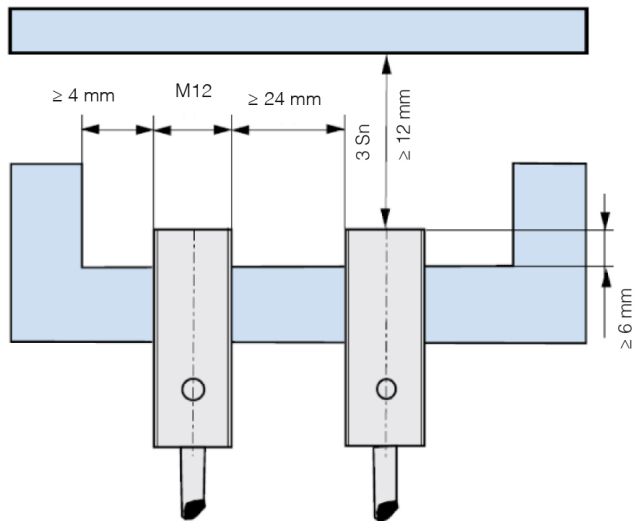

**Datasensing  
S.r.l.**

Strada S.Caterina, 235  
41122 Modena (MO)  
Tel. 059 420411  
Fax 059 253973  
E-mail  
info@datasensing.com

**date of  
printing**  
13/06/2026  
13:39:40