

Laser Sentinel

INSTRUCTION MANUAL



Safety Laser Scanner

Datasensing S.r.l.

Strada S. Caterina 235

41122 Modena

Italy

Tel. +39 059 420411

Fax +39 059 253973

© 2018-2023 Datasensing S.r.l.

All rights reserved. Without limiting the rights under copyright, no part of this documentation may be reproduced, stored in or introduced into a retrieval system, or transmitted in any form or by any means, or for any purpose, without the express written permission of Datasensing S.r.l. Owners of Datasensing products are hereby granted a non-exclusive, revocable license to reproduce and transmit this documentation for the purchaser's own internal business purposes. Purchaser shall not remove or alter any proprietary notices, including copyright notices, contained in this documentation and shall ensure that all notices appear on any reproductions of the documentation. Electronic versions of this document may be downloaded from the Datasensing website (www.datasensing.com).

Disclaimer

Datasensing has taken reasonable measures to provide information in this manual that is complete and accurate, however, Datasensing shall not be liable for technical or editorial errors or omissions contained herein, nor for incidental or consequential damages resulting from the use of this material. Datasensing reserves the right to change any specification at any time without prior notice.

Trademarks

Datasensing and the Datasensing logo are trademarks of Datasensing S.r.l. Datalogic and the Datalogic logo are registered trademarks of Datalogic S.p.A. in many countries, including the U.S. and the E.U.

Patents

See www.patents.datalogic.com for patent list.

Original Instructions (ref. 2006/42/EC)

This manual refers to software version 3.1.1 and later.

END USER LICENSE AGREEMENT

NOTICE TO END USER: BY DOWNLOADING OR INSTALLING THE SOFTWARE, OR BY USING THE DATALOGIC PRODUCT THAT INCLUDES THIS SOFTWARE, THE END USER CONSENTS TO BE BOUND BY THIS AGREEMENT. IF THE END USER DOES NOT AGREE WITH ALL OF THE TERMS OF THIS AGREEMENT, THEN DATALOGIC IS NOT WILLING TO LICENSE THE SOFTWARE AND THE END USER IS NOT ALLOWED TO DOWNLOAD, INSTALL OR USE THE SOFTWARE OR THE DATALOGIC PRODUCT

This End User License Agreement ("EULA") is between Datalogic IP Tech S.r.l. having its registered office at Via San Vitalino 13, 40012 Calderara di Reno (Bologna), Italy ("Datalogic"), and you, either an individual or a single entity, ("End User or "You") who has purchased one or more Datalogic Laser Sentinel ("Datalogic Product") subject to the terms and conditions provided in any relevant purchase or sale contract. This EULA applies to the software contained in the Datalogic Product ("Embedded Software") and to any other software, to the extent applicable, offered as optional application software ("Application Software" that together with "Embedded Software" is herein referred to as "Software").

1. Grant of License

1.1 Datalogic grants to End User, a personal, non-exclusive, non-transferable, non-sublicensable, revocable, limited license to use the Software, solely on the Datalogic Product in which it is embedded or for which it is intended for use, in machine-readable form only, solely for End User's internal business purposes.

1.2 End Users shall not distribute, sublicense, rent, loan, lease, assign, export, re-export, resell, ship or divert or cause to be exported, re-exported, resold, shipped or diverted, directly or indirectly, the Software under this Agreement. End User shall not, and shall not permit others to: (i) modify, translate, decompile, reverse engineer, disassemble, or extract the inner workings of the Software, (ii) copy the functionality of the Datalogic Products; (iii) remove any proprietary notices, marks, labels, or logos from the Datalogic Products; (iv) rent or transfer all or some of the Software to any other party without Datalogic's prior written consent.

1.3. Title to the licensed Software shall be and remain with Datalogic or the third party from whom Datalogic has obtained a license right. This Agreement does not grant to End User any intellectual property rights. As used in this Agreement the term "purchase" or its equivalent when applied to the Software shall mean "acquire under license". End User is not entitled to receipt or use of the source code of any licensed Software.

1.4 Portions of the Datalogic Product are protected by the relevant and applicable patent and copyright laws, international treaty provisions, and other applicable laws. Therefore, End User must treat the Datalogic Product like any other copyrighted material (e.g., a book or musical recording) except that End User may make one copy of the Software solely for back-up purposes. Unauthorized duplication of the Software constitutes copyright infringement.

1.5 Any use of the Software outside of the conditions set forth herein is strictly prohibited and will be deemed a breach of this Agreement resulting in immediate termination of this Agreement. In the event of a breach of this Agreement, Datalogic will be entitled

to all available remedies at law or in equity (including but not limiting to immediate termination of the license without notice, immediate injunctive relief and repossession of all Datalogic Products).

1.6 Without prejudice of the foregoing, End User grants to Datalogic and its independent accountants or consultants the right to examine End User's books, records and accounts during End User's normal business hours to verify compliance with this Agreement. In the event such audit discloses non-compliance with this Agreement, Datalogic shall be entitled to immediately terminate the Agreement, request End User to promptly pay all (additional) license fees due and any further damages, if any.

2. License Fee

License fees shall be due by End User to Datalogic according to the terms provided for in the relevant contract for the purchase of the Datalogic Product.

3. Termination

Without prejudice to any other rights or remedies Datalogic may have, Datalogic may terminate this Agreement if End User fails to comply with the terms and conditions of this Agreement. Datalogic may terminate this Agreement by offering you a superseding Agreement for the Software or any replacement or modified version of or upgrade to the Software and conditioning your continued use of the Software or such replacement, modified or upgraded version on your acceptance of such superseding Agreement. In addition, either party may terminate this Agreement at any time. Subject to the foregoing, termination shall be effective upon notice to the other party. In the event that this Agreement terminates for any reason, End User's license to use the Software will immediately terminate, and End User must immediately stop using the Software, destroy all copies of the Software and all of its component parts, and, upon request, provide an affidavit certifying your compliance with the foregoing. The provisions of Sub-sections 1.2, 1.3, 1.4, 1.5, 4, 5, 6, 8, and 11 shall survive termination of this Agreement.

4. Limited Warranty

Datalogic warrants that, under normal use and operation, the Software will conform substantially to the applicable Datalogic Product documentation for the period specified in the same, provided that the Software is used with the Datalogic Product. Datalogic's entire liability and End User's sole and exclusive remedy for any breach of the foregoing limited warranty will be, at Datalogic's option, the provision of a downloadable patch or replacement software.

Datalogic does not warrant (i) that Software will meet End User's requirements; (ii) that Software will be uninterrupted or defect error free; (iii) any non-conformity derived from unauthorized use, and/or improper installation or repair not in compliance with Datalogic Product documentation. End User agrees that the existence of such non-conformities or errors and Datalogic's inability to remedy such errors shall not constitute a breach of this Agreement.

EXCEPT AS PROVIDED IN THIS AGREEMENT, THE DATALOGIC PRODUCT IS PROVIDED "AS IS" AND DATALOGIC MAKES NO WARRANTIES OF ANY KIND, EXPRESS OR IMPLIED, WRITTEN OR ORAL, WITH RESPECT TO THE DATALOGIC PRODUCT OR SOFTWARE, AND SPECIFICALLY DISCLAIMS THE IMPLIED WARRANTIES OF MERCHANTABILITY AND FITNESS FOR A PARTICULAR PURPOSE.

5. Limitation of Liability

EXCEPT AS PROVIDED IN THIS AGREEMENT, NEITHER DATALOGIC NOR ITS LICENSORS SHALL BE LIABLE FOR ANY CLAIMS AGAINST END USER BY ANY OTHER PARTY. IN NO EVENT SHALL DATALOGIC'S LIABILITY FOR DAMAGES, IF ANY, WHETHER BASED UPON

CONTRACT, TORT (INCLUDING NEGLIGENCE), PRODUCT LIABILITY, STRICT LIABILITY, WARRANTY, OR ANY OTHER BASIS, EXCEED THE PRICE OR FEE PAID BY END USER FOR THE DATALOGIC PRODUCT. UNDER NO CIRCUMSTANCES SHALL DATALOGIC OR ITS LICENSORS BE LIABLE TO END USER OR ANY THIRD PARTY FOR LOST PROFITS, LOST DATA, INTERRUPTION OF BUSINESS OR SERVICE, OR FOR ANY OTHER SPECIAL, CONSEQUENTIAL, CONTINGENT, INDIRECT, INCIDENTAL, PUNITIVE, EXEMPLARY, OR OTHER SIMILAR DAMAGES, EVEN IF DATALOGIC OR ITS LICENSORS HAVE BEEN ADVISED OF THE POSSIBILITY OF SUCH DAMAGES. END USER MUST BRING ANY ACTION UNDER THIS AGREEMENT WITHIN 12 (TWELVE) MONTHS AFTER THE CAUSE OF ACTION ARISES.

6. Indemnification

To the maximum extent permitted by law, End User agrees to defend, indemnify and hold harmless Datalogic, its affiliates and their respective directors, officers, employees and agents from and against any and all claims, actions, suits or proceedings, as well as any and all losses, liabilities, damages, costs and expenses (including reasonable attorney's fees) arising out of or accruing from or related to Licensee's failure to comply with the terms of this Agreement, including but not limited to (1) noncompliance with any applicable laws or regulations with Datalogic product documentation, (2) unauthorized use or disclosure of Software, and (3) use of Software in combination with software, hardware, systems, or other items not provided by Datalogic.

7. Support

End User may request support for Software from Datalogic at Datalogic's standard support fees and under Datalogic's standard support terms and conditions in effect at the time the support is requested.

8. Government Restricted Rights; International Use

8.1 Use, duplication, or disclosure of the Software by the U.S. Government is subject to the restrictions for computer software developed at private expense as set forth in the U.S. Federal Acquisition Regulations at FAR 52.227-14(g), or 52.227-19 or in the Rights in Technical Data and Computer Software clause at DFARS 252.227-7013(c)(1)(ii), whichever is applicable.

8.2 If End User is using the Datalogic Product outside of the United States, End User must comply with the applicable local laws of the country in which the Datalogic Product is used and with U.S. export control laws. Without prejudice of the foregoing, the End User agrees to not export or re-export the Software, any part thereof, or any process or service that is the direct product of the Software to any country, person or entity subject to U.S. export restrictions. End User specifically agrees not to export or re-export any of the Software: (i) to any country to which the U.S. has embargoed or restricted the export of goods or services or to any national of any such country, wherever located, who intends to transmit or transport the Software back to such country; (ii) to any person or entity who you know or have reason to know will utilize the Software in the design, development or production of nuclear, chemical or biological weapons; or (iii) to any person or entity who has been prohibited from participating in U.S. export transactions by any federal agency of the U.S. government. End User warrants and represents that neither the U.S. Commerce Department, Bureau of Export Administration nor any other U.S. federal agency has suspended, revoked or denied its export privileges.

9. Third Party Software

The Datalogic Product may contain one or more items of third party software which use is governed by separate third party license, unless otherwise stated.

10. Notices

All notices required or authorized under this Agreement shall be given in writing, and shall be effective when received, with evidence of receipt. Notices to Datalogic shall be sent to the attention of Datalogic IP Tech S.r.l., Legal & IP Department, Via San Vitalino 13, 40012 Calderara di Reno (Bologna), Italy, or such other address as may be specified by Datalogic in writing.

11. General Provisions.

11.1. Entire Agreement; Amendment. This document contains the entire agreement between the parties relating to use of the Datalogic Products and the licensing of the Software and supersedes all prior or contemporaneous agreements, written or oral, between the parties concerning the use of the Datalogic Products and licensing of the Software. This Agreement may not be changed, amended, or modified except by written document signed by Datalogic.

11.2. Waiver. A party's failure to enforce any of the terms and conditions of this Agreement shall not prevent the party's later enforcement of such terms and conditions.

11.3. Governing Law; Venue: End User agrees to the application of the laws of the country in which End User obtained the license to govern, interpret, and enforce all of End User's and Datalogic's respective rights, duties, and obligations arising from, or relating in any manner to, the subject matter of this Agreement, without regard to conflict of law principles. The United Nations Convention on Contracts for the International Sale of Goods does not apply.

All rights, duties, and obligations are subject to the courts of the country in which End User obtained the license. For licenses granted by Licensee who operates in the countries specified below, the following terms applies.

For Americas:

This Agreement is governed by the laws of the State of Oregon. This Agreement and the rights of the parties hereunder shall be governed by and construed in accordance with the laws of the State of Oregon U.S.A, without regard to the rules governing conflicts of law. The state or federal courts of the State of Oregon located in either Multnomah or Lane counties shall have exclusive jurisdiction over all matters regarding this Agreement, except that Datalogic shall have the right, at its absolute discretion, to initiate proceedings in the courts of any other state, country, or territory in which End User resides, or in which any of End User's assets are located. In the event an action is brought to enforce the terms and conditions of this Agreement, the prevailing party shall be entitled to reasonable attorneys' fees, both at trial and on appeal.

For Europe, Middle East and Africa:

This Agreement is governed by the laws of Italy. This Agreement and the rights of the parties hereunder shall be governed by and construed in accordance with the laws of Italy, without regard to the rules governing conflicts of law. Italian Court of Bologna shall have exclusive jurisdiction over all matters regarding this Agreement, except that Datalogic shall have the right, at its absolute discretion, to initiate proceedings in the courts of any other state, country, or territory in which End User resides, or in which any of End User's assets are located. In the event an action is brought to enforce the terms and conditions of this Agreement, the prevailing party shall be entitled to reasonable attorneys' fees, both at trial and on appeal.

For Asia- Pacific Countries:

The validity, interpretation and construction of the Agreement shall be governed by and construed in accordance with Laws of the Republic of Singapore. Parties expressly disclaim the application of the United Nations Convention for International Sale of Goods.

Any dispute arising out of or in connection with this contract, including any question regarding its existence, validity or termination, shall be referred to and finally resolved by arbitration administered by the Singapore International Arbitration Centre ("SIAC") in accordance with the Arbitration Rules of the Singapore International Arbitration Centre ("SIAC Rules") for the time being in force, which rules are deemed to be incorporated by reference in this clause. The seat of the arbitration shall be Singapore.

The number of arbitrators will be three, with each side to the dispute being entitled to appoint one arbitrator. The two arbitrators appointed by the parties will appoint a third arbitrator who will act as chairman of the proceedings. Vacancies in the post of chairman will be filled by the president of the SIAC. Other vacancies will be filled by the respective nominating party. Proceedings will continue from the stage they were at when the vacancy occurred. If one of the parties refuses or otherwise fails to appoint an arbitrator within 30 days of the date the other party appoints its, the first appointed arbitrator will be the sole arbitrator, provided that the arbitrator was validly and properly appointed. All proceedings will be conducted, including all documents presented in such proceedings, in the English language. The English language version of these terms and conditions prevails over any other language version.

11.4. Attorneys' Fees. In the event an action is brought to enforce the terms and conditions of this Agreement, the prevailing party shall be entitled to reasonable attorneys' fees, both at trial and on appeal.

- END -

TABLE OF CONTENTS

END USER LICENSE AGREEMENT	III
PREFACE	XI
About this Manual	xi
Manual Conventions	xi
Technical Support	xi
Support Through the Website	xi
GENERAL VIEW	XIII
Laser Sentinel Master Model	xiii
Laser Sentinel Slave Model	xiv
Laser Sentinel Stand Alone Model	xv
LEDs and Indicators	xvi
Model Selection and Order Information	xvii
Connectors used	xvii
CHAPTER 1. GENERAL INFORMATION	1
General Description	1
Reference Standards and Regulations	2
Package Contents	3
Basic Information	3
CHAPTER 2. TYPICAL APPLICATIONS	4
Horizontal Application Configuration	5
Vertical Application Configuration	6
Applications with Master and Slave Connection	7
CHAPTER 3. SAFETY INFORMATION	8
CHAPTER 4. INSTALLATION	10
Installation Precautions	10
Getting Started	11
Precautions for Environmental Interference	11
Light Interference	12
High Reflecting Background	13
Zone with Limited Detection Capability	14
Device Positioning and Minimum Distance Calculations	15
Minimum Safety Distance Calculations for Horizontal Applications	16
Minimum Safety Distance Calculations for Vertical Applications	19
Minimum Safety Distance Calculations for Mobile Applications	21
Unprotected Zone	24
Distance to Wall	25
Devices Orientation	26
Checks After First Installation	28
CHAPTER 5. MECHANICAL MOUNTING	30
Direct Mounting	31
Protection Bracket Mounting (SLS-BRACKET-C) (Optional)	32
Angle Adjustment Bracket Mounting	33

Pitch and Roll Angle Adjustment Bracket (SLS-BRACKET-A)	33
Pitch Angle Adjustment Bracket (SLS-BRACKET-B)	34
Scanner Mounting and Pitch Angle Adjustment	35
Roll Angle Adjustment	37
Memory Group Unmounting for Cable Connection	38
Safety Information Regarding Mounting	40
CHAPTER 6. ELECTRICAL CONNECTIONS	41
Laser Sentinel Stand Alone Model Connectors	41
Machine Interface Connections	42
Master Slave System Connection	43
Master Connection	44
Master M12 8-Pole Connector	44
Master M12 12-Pole Connector	45
Master M12 17-Pole Connector	47
Master M12 17+8 Pole Connector	48
Laser Sentinel: The Slave	52
Master Slave Connection	53
Power Supply Connections	54
PC Connections	54
CHAPTER 7. LASER SENTINEL SETUP AND CONFIGURATION	55
Installing DLSentinel GUI	55
Minimum System Requirements	55
Program Installation	56
Choosing the Application	56
CHAPTER 8. FUNCTIONS	57
Zone Setting Configuration and Selection	57
Zone Set Input Selection	57
Zone Set Switching	58
Detection Capability Setting	63
Automatic and Manual Restart	64
Response Time and Scan Cycle Setting	66
Reference Points Monitoring Settings	68
Safety Outputs (OSSDs)	70
OSSD test	71
Muting	72
Muting Enable	73
Muting Signaling Devices	73
Muting Direction	73
Bidirectional Muting	73
Unidirectional Muting	75
Configuring the Muting Function on DLSentinel	76
Override	79
Muting Dependent Override in Stand Alone Model	79
Muting Dependent Override in Master Model	79
EDM	81
Encoders	83
Anti-Interference Coding	88
Dust Filtering	89
Shut Off	90
Reset	91
Auto Reset	91
Wink	92
Safety Report Generation and Acceptance	93
CHAPTER 9. DIAGNOSTICS	94
Monitoring by Display	94
Diagnostic Notes, Warnings, and Errors	95

Anti-Tamper Function	100
Safety	101
LEDs and Display	102
Diagnostic and Status LEDs	102
Display Menu	103
Diagnostics Using the Display	103
Diagnostic Log	104
Periodical Checks	106
CHAPTER 10. DEVICE MAINTENANCE.....	107
General Information and Useful Data	107
Window Cleaning	108
Window Replacement	110
Warning Terms - Disclaimer for Window Replacement and Calibration	110
Prerequisites for Window Replacement	111
Window Replacement Procedure	112
New Window Calibration	115
Fast Replacement	121
Fast Replacement of the Memory Group	121
Fast Replacement of the Master device	122
Fast Replacement of a Slave device	123
Firmware Update	124
Checks after Firmware Update	125
TECHNICAL DATA	126
OVERALL DIMENSIONS	131
Laser Sentinel Stand Alone Model	131
Laser Sentinel Master Model	132
Laser Sentinel Slave Model	132
ACCESSORIES	133
Mounting Brackets	133
Ethernet Cables	134
Electrical Cables	134
Safety Units	135
Maintenance Accessories	135
GLOSSARY	136

PREFACE

ABOUT THIS MANUAL

This Instruction Manual is provided for users seeking advanced technical information, including connection, programming, maintenance and specifications. The Quick Reference Guide (QRG) and other publications associated with this product can be downloaded free of charge from the website listed on the back cover of this manual.

Manual Conventions

The following conventions are used in this document:

The symbols listed below are used in this manual to notify the reader of key issues or procedures that must be observed when using the reader:



NOTE

Notes contain information necessary for properly diagnosing, repairing and operating the reader.



CAUTION

The CAUTION symbol advises you of actions that could damage equipment or property.



WARNING

The WARNING symbol advises you of actions that could result in harm or injury to the person performing the task and/or persons in the vicinity of the source of danger.

TECHNICAL SUPPORT

Support Through the Website

Datasensing provides several services as well as technical support through its website. Log on to (www.datasensing.com).

For quick access, from the home page click on the search icon , and type in the name of the product you're looking for. This allows you access to download Data Sheets, Manuals, Software & Utilities, and Drawings.

GENERAL VIEW

LASER SENTINEL MASTER MODEL



1. Ethernet Input Connector (configuration PC or host)
2. Direct Mounting Holes (2)
3. Bracket Mounting Holes (4)
- 4.-5. I/O Connectors (8+12 poles or 17+8 poles, according to model)
6. Ethernet Output Connector (to Slaves)
7. Device Class and Warning Labels

Figure 1 - Master model

LASER SENTINEL SLAVE MODEL



- 1. Laser scanner window
- 2. Display
- 3. LED Indicators
- 4. Keypad
- 5. Ethernet Input Connector
- 6. Ethernet Output Connector
- 7. Device Class and Warning Labels
- 8. Direct Mounting Holes (2)

Figure 2 - Slave model

LASER SENTINEL STAND ALONE MODEL











- | | |
|-------------------------|------------------------------------|
| 1. Laser scanner window | 5. Keypad |
| 2. Display | 6. I/O Connector (8 poles) |
| 3. LED Indicators | 7. Device Class and Warning Labels |
| 4. Ethernet Connector | 8. Direct Mounting Holes (2) |

Figure 3 - Stand Alone model

LEDS AND INDICATORS



Figure 4 - Laser Sentinel LEDs and Indicators

SYMBOL	DEFINITION	COLOR	MEANING	OUTPUT STATUS
	LED 1: Object Detection in Safety Zone 1 (OSSD 11/12)	Green	No object detected in Safety Zone 1	OSSDs ON
		Red	Object detected in Safety Zone 1	OSSDs OFF
	LED 2: Object Detection in Safety Zone 2 (OSSD 21/22)	Green	No object detected in Safety Zone 2	OSSDs ON
		Red	Object detected in Safety Zone 2	OSSDs OFF
	LED 3: Object Detection in Safety Zone 3 / Warning Zone 2	Green	No object detected in Safety Zone 3	OSSDs ON
		Red	Object detected in Safety Zone 3	OSSDs OFF
		Amber	Object detected in Warning Zone 2	Warning 2 Output OFF if set up
		Off	No object detected in Warning Zone 2	Warning 2 Output ON if set up
	LED 4: Object Detection in Warning Zone	Amber	Object detected in Warning Zone 1	Warning 1 Output OFF
		Off	No object detected in Warning Zone 1	Warning 1 Output ON
	LED 5: Interlock	Amber	No object detected in Safety Zone Device waiting for manual restart (LED 1 red)	OSSDs OFF
		Off	No object detected in Safety Zone Device in ON Status (LED 1 green)	OSSDs ON
			Object detected in Safety Zone Device in OFF Status (LED 1 red)	OSSDs OFF
	Button 1: to quickly browse the Menu functions			
	Button 2: to quickly browse the Menu and confirm the selected function			
	Button 3: to quickly browse the Menu functions			



NOTE

For further information refer to "LEDs and Display" on page 102.

MODEL SELECTION AND ORDER INFORMATION

MODEL	DESCRIPTION	CODE
SLS-SA5-08	Stand Alone 5.5 m 6 zone sets Enhanced	958001090
SLS-SA3-08	Stand Alone 3 m 6 zone sets Enhanced	958001080
SLS-M5-0812	Master 5.5 m 10 zone sets	958001040
SLS-M5-0812-E	Master 5.5 m 10 zone sets Enhanced	958001110
SLS-M3-0812-E	Master 3 m 10 zone sets Enhanced	958001020
SLS-M5-1708-E	Master 5.5 m 70 zone sets Enhanced	958001030
SLS-M5-E-1708-E	Master 5.5 m Encoder 70 zone sets Enhanced	958001050
SLS-M3-1708-E	Master 3 m 70 zone sets Enhanced	958001010
SLS-R5	Remote 5.5 m	958001070
SLS-R5-E	Remote 5.5 m Enhanced	958001120
SLS-R3-E	Remote 3 m Enhanced	958001060

CONNECTORS USED

MODEL	CONNECTORS
SLS-SA5-08	M12 4-pin front connector (Ethernet port)
SLS-SA3-08	M12 8-pin connector on the memory group (power, I/O)
SLS-M5-0812	M12 4-pin rotatable side connector (Ethernet port)
SLS-M5-0812-E	M12 8-pin rotatable side connector (connection to Slave device)
SLS-M3-0812-E	M12 8-pin connector on the memory group (power, I/O)
	M12 12-pin connector on the memory group (power, I/O)
SLS-M5-1708-E	M12 4-pin rotatable side connector (Ethernet port)
SLS-M5-E-1708-E	M12 8-pin rotatable side connector (connection to Slave device)
SLS-M3-1708-E	M12 17-pin or 17+8 pin connector on the memory group (power, I/O)
	M12 8-pin connector on the memory group (power, I/O)
SLS-R5	M12 4-pin rotatable side connector (connection to Master or previous Slave device)
SLS-R5-E	
SLS-R3-E	M12 8-pin rotatable side connector (connection to next Slave device)

CHAPTER 1

GENERAL INFORMATION

GENERAL DESCRIPTION

The Laser Sentinel is an electro-sensitive protective equipment (ESPE). It employs active opto-electronic protective devices responsive to the diffuse reflection of a radiation (AOPDDR), according to the definition and requirements of international safety standard IEC 61496-3. The optical radiation is a Class 1 infrared laser generated within the device.

If the device is applied to a machine that presents a risk of personal injury, it provides protection by making the machine revert into a safe condition before a person reaches the hazardous points.

The working principle is: the invisible beam of the laser creates a two-dimensional safety area that must be necessarily crossed in order to reach the dangerous point. In this way, the dangerous movement of the machine can be stopped before anyone reaches the hazard point.

The safety area can be horizontal and by using a Graphic User Interface, its shape can be planned according to application needs.

The beam is emitted in short interval pulses and they are reflected by the objects in the safety area. The device calculates the distance from the objects by measuring the time interval between the transmission of the pulse and its reception after being reflected (time-of-flight principle).

The safety area is scanned by a mirror that deflects the light pulses over 275 ° around the device by rotating at a constant speed. In this way, all the opaque objects that have a certain dimension can be detected in the safety area.

Within the sensing range of the device, two areas can be monitored simultaneously: one is the Safety Zone, which is used to detect operators or objects entering a hazardous area; the other is the Warning Zone, which can be defined with a longer distance than a Safety Zone, allowing a configuration to detect objects that are closely approaching the Safety Zone.

REFERENCE STANDARDS AND REGULATIONS

The safety laser scanner is a safety system used as an accident-prevention protection device and is manufactured in accordance with the international Standards in force for safety, in particular:

STANDARD	DESCRIPTION
2014/30/EU EMC Directive	Harmonisation of the laws of the Member States relating to electromagnetic compatibility.
2006/42/EC Machinery Directive	Harmonisation of essential health and safety requirements for machinery.
2011/65/EU RoHS Directive	Restriction of the Use of Certain Hazardous Substances in Electronic and Electrical Equipment.
IEC 61496-3: 2019	Safety of machinery - Electro-sensitive protective equipment - Part 3: Particular requirements for Active Optoelectronic Protective Devices responsive to Diffuse Reflection (AOPDDR).
EN/IEC 61496-1:2020 Type 3	Safety of the machinery – Electro-sensitive protective equipment – Part 1: General requirements and tests.
EN ISO 13849-1:2015 (Cat. 3, PL d,)	Safety of machinery. Safety-related parts of control systems. Part 1: General principles for design.
IEC 61508-1:2010 (SIL 2)	Functional safety of electrical/electronic/programmable electronic safety related systems. Part 1: General requirements.
IEC 61508-2:2010 (SIL 2)	Functional safety of electrical/electronic/programmable electronic safety related systems. Part 2: Requirements for electrical/electronic/programmable electronic safety related systems.
IEC 61508-3:2010 (SIL 2)	Functional safety of electrical/electronic/programmable electronic safety related systems. Part 3: Software requirements.
IEC 61508-4:2010 (SIL 2)	Functional safety of electrical/electronic/programmable electronic safety related systems. Part 4: Definitions and abbreviations.
IEC 62061: 2021 (SIL2, maximum SIL2)	Safety of machinery. Functional safety of electrical/ electronic/programmable electronic safety related control systems.
IEC 60825-1:2014	Safety of laser products – Part 1: Equipment classification and requirements.
IEC TS 62046:2008	Safety of machinery – Application of protective equipment to detect the presence of persons.
IEC 61784-3-18 2010	Industrial communication networks - Profiles - Part 3-18: Functional safety fieldbuses - Additional specifications for CPF 18
EN 60529:1991/A1:2000/A2:2013	Degrees of protection provided by enclosures (IP Code).

Some parts or sections of this manual containing important information for the user or for the installing operator are preceded by a note:



The information provided in the paragraphs following this symbol is very important for safety and may prevent accidents.

Always read this information accurately and carefully follow the advice to the letter.

As the required knowledge may not be completely included in this manual, we suggest contacting the Technical Service for any further information relative to the functioning of the safety laser scanner and the safety rules that regulate the correct installation of the device (refer to [Chapter 4, Installation](#)).

PACKAGE CONTENTS

Package contains the following objects:

- Laser Sentinel
- Quick Reference Guide of Laser Sentinel
- Periodical checklist and maintenance schedule

BASIC INFORMATION

The user can follow the indications related to typical application configurations that facilitate the device programming. Two types of configuration have been developed on DL Sentinel so far:

1. **Vertical application configuration** (refer to the DLSentinel User's Manual).
2. **Expert application configuration** (refer to the DLSentinel User's Manual).

CHAPTER 2

TYPICAL APPLICATIONS

The safety laser scanner is used to detect people who are approaching a hazardous area before reaching it, in order to prevent hazardous circumstances (e.g. a mechanical movement) that may cause an accident.

The protective detection is done by defining a Safety Zone (the red zone in the figures), whose shape and dimensions must be designed according to the risk assessment of the machine. The user must consider the position of the hazardous point, the shape of the machine and of the environment that surrounds it, and the time needed to stop the dangerous movement.

To better ensure people's safety, it is possible to define a Warning Zone (the yellow zone in the figures): if a person or an object is approaching too close to the Safety Zone, the safety laser scanner will trigger warning signals. This area cannot be used for safety purposes.

The possible applications to employ the Laser Sentinel are: Horizontal (to monitor an area that must be crossed in order to reach the hazardous point) and Vertical (to monitor an access point).

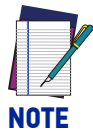

NOTE

The following application examples are provided for instructional purposes.

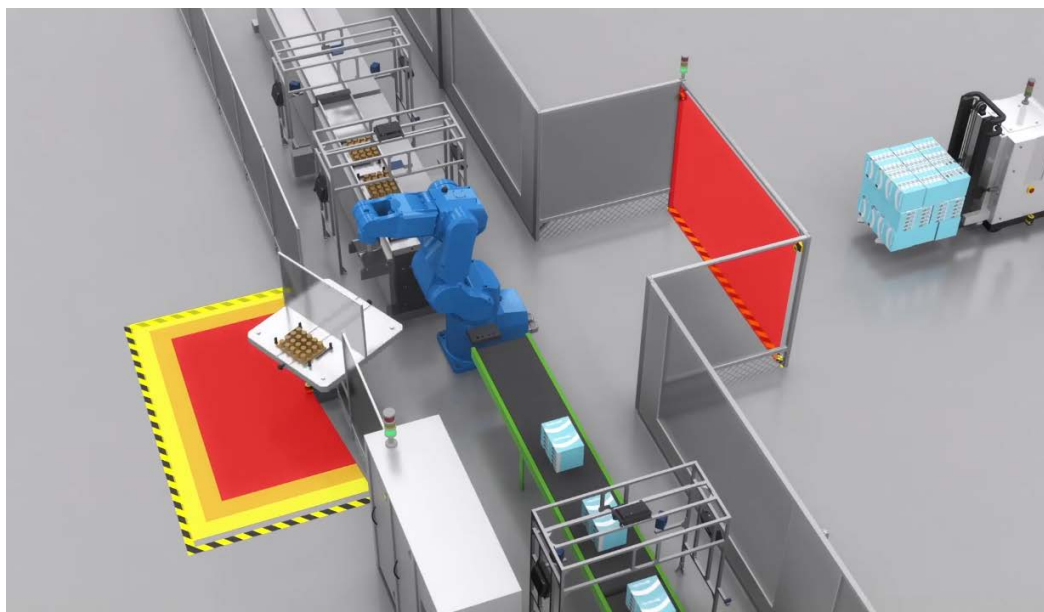

Figure 1 - Application Example

HORIZONTAL APPLICATION CONFIGURATION

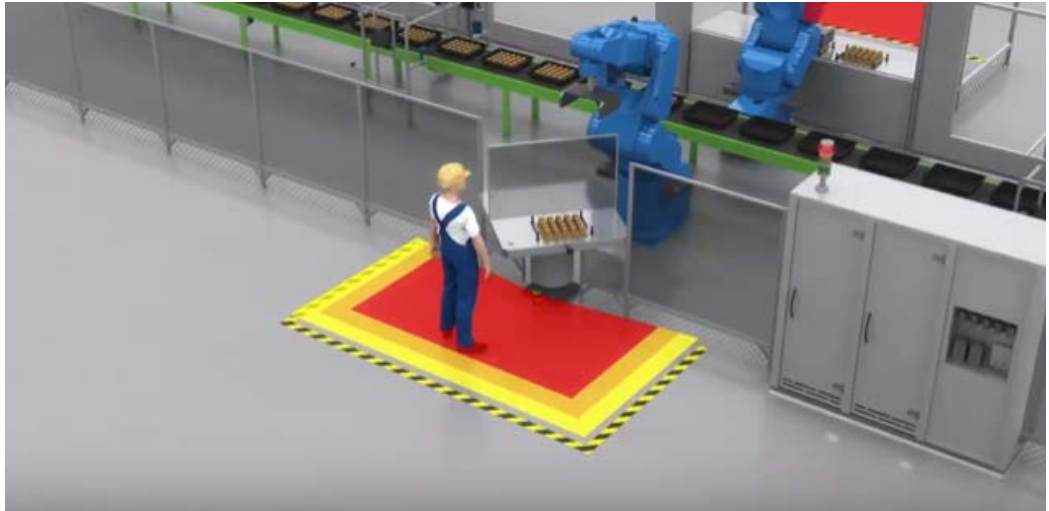

Figure 2 - Static horizontal configuration

The device uses a horizontal protective field (the red area in the figures) to detect the presence of an object or a person.

The Laser Sentinel will scan the environment surrounding the hazardous point to detect approaching objects or people. If someone is detected in the safety zone (with a given detection capability), a stopping signal is sent to the machine by the device. This signal will stop the machine by putting the OSSDs in OFF state.

In this example a Warning Zone has been defined (yellow zone in the figure) in order to give a preliminary warning if someone is detected, to prevent operators from accidentally stopping the working process of the machine. The warning signals are sent using non-safe outputs assigned to the area.

VERTICAL APPLICATION CONFIGURATION



Figure 3 - Vertical application

The device uses a vertical protective field (the red area in the figure) to detect someone passing through it.

In this example the only way to reach the hazardous point is to pass through an opening: all other access points to the machine are protected by some physical barrier or other sensors.

The safety laser scanner employs a safe vertical protective field (the red area in the figure) to detect any passage through this access point (with a given detection capability, i.e. 40 mm, needed to detect an arm).

If the device detects someone crossing the safety zone, the OSSD pair goes to the OFF-state to stop the machine movement that is causing the hazard.

When a person has completely passed through the monitored area, after a stop caused by safety function, the machine must remain stopped until a manual restart signal is given. This signal must be given only after checking that nobody remains in or close to the hazardous point.



NOTE

When the approach direction is $> 30^\circ$ or $< -30^\circ$ relative to the detection plane itself, the safety laser scanner shall have a facility for reference boundary monitoring, according to IEC 61496-3.

APPLICATIONS WITH MASTER AND SLAVE CONNECTION

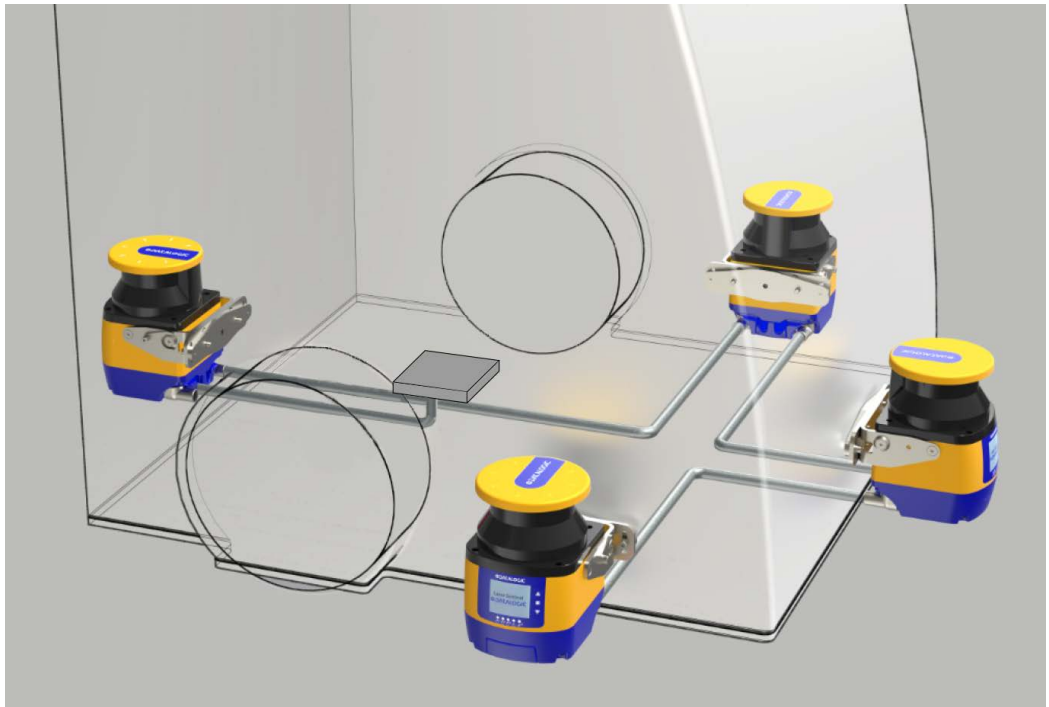

Figure 4 - Master/Slave application

In several applications (such as robot cells, AGVs, etc.), there is a need to monitor several zones that are not visible from just one point, e.g. two opposite sides of a rectangle. In such cases, the use of several scanners is required. However, there may be just one safety function (i.e. the dangerous movement that must be stopped when someone is detected inside the safety area).

The Laser Sentinel can effectively solve this situation: irrespective of the use in horizontal or vertical position, up to 4 Laser Sentinel units can be easily connected to each other through Ethernet-based safe communication bus, working as a single system.

Only the Master Unit receives power, has inputs and outputs onboard, and must be connected to a PC in order to configure the whole system. The Slave Units (or Remote Units) are connected to the Master with a single cable that also provides them with power.

The synchronization of the four scanners is an integrated function. There is no need for external control units.

CHAPTER 3

SAFETY INFORMATION



For a correct use of the Safety Laser Sentinel, the following points must be observed.

- The machine stopping system must be electrically controlled.
- This control system must be able to stop the dangerous movement of the machine within the total machine stopping time T and during all the working cycle phases.
- The device mounting and connections must be carried out by qualified personnel only, according to the indications included in the specific sections (refer to [Chapter 5, Mechanical Mounting](#) and [Chapter 6, Electrical Connections](#)) and in the applicable standards.
- The safety laser scanner must be securely placed in such a position that access to the dangerous zone is not possible without passing through the safety area. This must be done according to the indications included in the specific section (refer to [Chapter 4, Installation](#)) and in the applicable standards.
- The personnel operating in the dangerous area must be well trained and must have adequate knowledge of all the operating procedures of the safety laser scanner.
- In case of Manual Restart, the Restart button must be located outside the safety area to let the operator control the safety zone during resetting or testing sessions.
- Please carefully read the instructions for correct functioning before powering the device.
- The requirements for the electrical safety and electromagnetic compatibility and the regulations or standards in all countries and/or regions must be met by the power supply where the Laser Sentinel is used. If the device power supply is shared with the machine or other electronic devices, voltage reduction to the Laser Sentinel or noise influence on the device may occur due to the temporary increase of the current consumption on the machine or other electronic devices. We do not recommend sharing the Laser Sentinel power supply with the one for the machine or other electronic devices, as the device may go into Error status.
- Do not place the connection cables in contact with or near high-voltage cables and/or cables with undergoing high current variations (e.g. motor power supplies, inverters, etc.).
- Do not connect any of the Laser Sentinel inputs to DC power sources outside of the declared range or to any AC power source, to avoid the risk of electric shock.

-
- Every access to the configuration tools must be allowed only to restricted and highly qualified personnel. The configuration upload through the GUI is only allowed by password.
 - Periodically monitor the optical window during the entire product life-cycle checking for any damage, scratches or dirt spots. In the presence of highly reflective backgrounds, these may cause a reduction in the detection capability of the scanner.
 - The laser scanner must not be used underwater or in explosive hazardous areas.
 - The laser scanner is not suitable for outdoor use.



Class 1 laser product. Invisible laser radiation. Do not view directly with optical instruments. IEC 60825-1:2007 & 2014.



WARNING

Failing to respect the instructions contained in this manual may affect the detection capability and correct functioning of the laser scanner.

CHAPTER 4

INSTALLATION

INSTALLATION PRECAUTIONS



Make sure that the protection level assured by the Laser Sentinel is compatible with the danger level of the working machine, according to EN ISO 13849-1 or EN 62061.

- It must not be possible for operators to approach the dangerous zone without being detected by the Laser Sentinel.
- Attach guard plates or other physical barriers to prevent access to dangerous areas that are not protected by the Laser Sentinel.
- The dimensions of the smallest object to be detected must be larger than the minimum detection capability of the device (refer to "[Detection Capability Setting](#)" on page 63).
- The OSSDs must be used as stopping devices and not as command devices. The machine must have its own START command.
- The operator must only use the components mentioned in the document and follow the indicated procedures (refer to [Chapter 5, Mechanical Mounting](#), [Chapter 6, Electrical Connections](#), [Chapter 7, Laser Sentinel Setup and Configuration](#), and [Chapter 10, Device Maintenance](#)).
- Improper use of the safety device can lead to malfunctioning.
- The device must only be repaired by authorized personnel.
- Reaching under, over or around, crawling beneath or stepping over the detection zone of the safety laser scanner must not be permitted.
- The safety laser scanner must be mounted securely and must not be able to be moved.
- Make sure that the Laser Sentinel output window is not obstructed by any object (do not obstruct the front highlighted in the figure below).

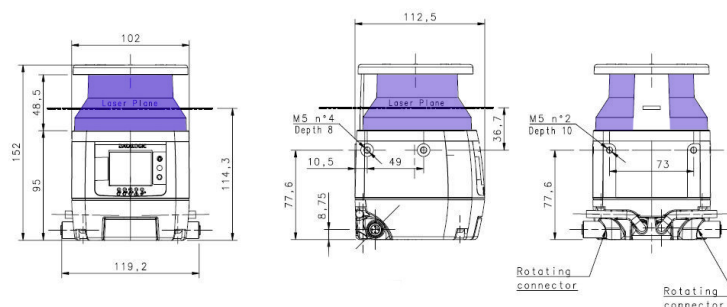

GETTING STARTED

Here are the basic steps to start a safety configuration.

- **Package Contents:** Check that the Laser Sentinel and all parts supplied with the equipment are present and intact when opening the packaging (refer to "[Package Contents](#)" on page 3).
- **Read all safety information** in [Chapter 3, Safety Information](#) before proceeding.
- **Mechanical Mounting:** Laser Sentinel can be installed to operate in different positions, make sure to follow the exact procedure (refer to [Chapter 5, Mechanical Mounting](#)).
- **Electrical Connections:** Laser Sentinel must be connected to the application through the required accessory cables (refer to [Chapter 6, Electrical Connections](#)).
- **Software Configuration:** Software configuration of Laser Sentinel can be accomplished through the Configuration procedure using the DLSentinel GUI (refer to [Chapter 7, Laser Sentinel Setup and Configuration](#)).

PRECAUTIONS FOR ENVIRONMENTAL INTERFERENCE

- The presence of intense electromagnetic interference may affect the correct functioning of the device. This condition shall be carefully evaluated by seeking the advice of our Technical Service.
- A sudden change in the environment temperature (e.g. with very low minimum peaks) can generate a small condensation layer on the laser and compromise proper operation.
- The operating distance of the device can be reduced in the presence of smog, fog or airborne dust.
- Installation must be performed by qualified personnel after making sure that the window is clean and free from scratches, dust, dirt spots and fingerprints. For more information, refer to [Chapter 10, Device Maintenance](#).
- Failure to inspect the window or set the proper environmental condition during installation may lead to a reduced detection capability of the scanner.

Light Interference

Reflecting surfaces located near the safety device may cause passive reflections. These can affect the detection of an object inside the safety zone. The passive light sources can be an incandescent lamp, sunlight, a fluorescent light, a strobe light or other infrared light sources (e.g. infrared laser).

Do not install the safety device near strong and/or flashing light sources.

Ambient light may interfere with the functioning device. If the installation requires direct exposure to ambient light, the scanner must be positioned so that the light does not enter the output window within $\pm 5^\circ$ of the detection plane.

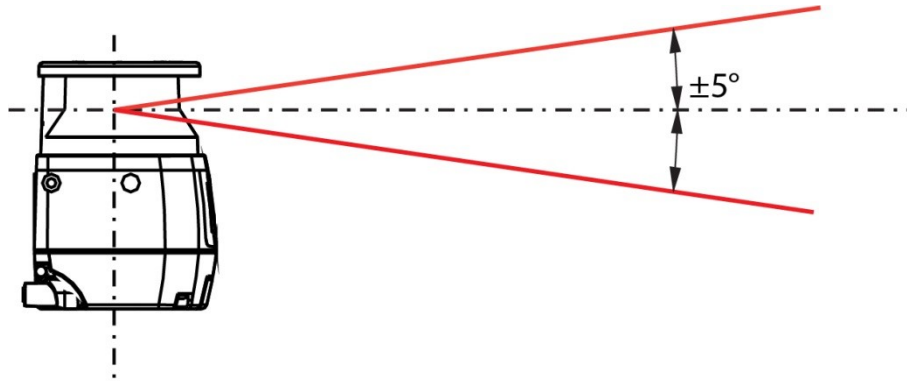

Figure 1 - Light interference avoidance



NOTE

In all applications where strong light within $\pm 5^\circ$ of the detection plane cannot be avoided, an additional distance must be applied to the Minimum Safety Distance Calculations. This distance could be influenced by the selected Dust Filter Level and the contemporary presence of reflecting background on light source (e.g. halogen lamp with back reflector). Typically, an additional distance of 200 mm is enough to prevent any reduction in the detection capability.



NOTE

In any case where bright light is present outside the $\pm 5^\circ$ range, the additional distance is still highly recommended.



NOTE

In case of both light interference and high reflecting background, additional distances are not summed, but the highest distance should be used.

High Reflecting Background

If there is a high reflecting background within 3 meters of the safety zone boundary, e.g. a metallic glossy surface, the Laser Sentinel might fail to recognize the exact distance of the detected object because of an increase in the measure error.

In this circumstance, it is recommended to reduce or remove the reflecting background. In cases where this cannot be avoided, an additional distance must be applied to the minimum safety distance calculation. This distance depends on the Dust Filter Level and on the background characteristics. Typically, an additional distance of 200 mm is enough to prevent any reduction in the detection capability.

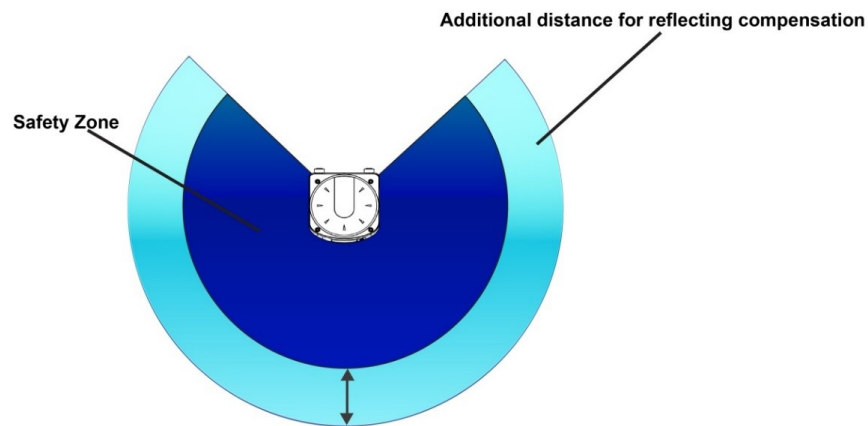
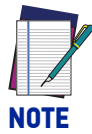

Figure 2 - High Reflective Background



NOTE

This additional distance based on the highly reflecting background influence range of 3 meters is relative to a reflective background test target of $300 \text{ cd m}^{-2} \text{ lx}^{-1}$. For higher values of background reflectance, further risk analysis must be done to evaluate the effective influence range and eventually to increase the additional distance.

The presence of dirt spots, damage or scratches to the optical window may have an impact on additional distance evaluation and potentially may reduce the detection capability. Perform window cleaning according to "Window Cleaning" on page 108.



NOTE

In case of both light interference and high reflecting background, additional distances are not summed, but the highest distance should be used.

ZONE WITH LIMITED DETECTION CAPABILITY

Laser Sentinel may not properly detect an object located at a distance of 10 cm or less from the safety zone origin. This zone is called “zone with limited detection capability.”

In this circumstance, a risk assessment is recommended taking into account the possibility that an object can cross a zone with limited detection capability. If possible, responsible personnel must provide an additional solution.

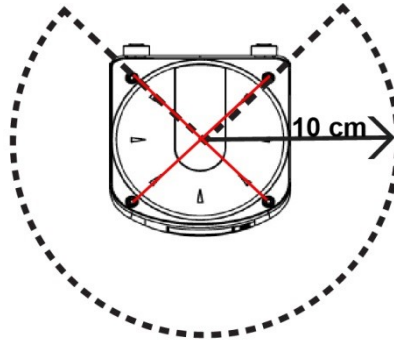

Figure 3 - Limited Detection Capability



WARNING

The operator is responsible for the configuration and for ensuring that the zone of limited detection does not create hazardous circumstances.

DEVICE POSITIONING AND MINIMUM DISTANCE CALCULATIONS

The Laser Sentinel must be carefully positioned to fulfill its safety function. In fact, access to the dangerous area must only be possible by passing through the safety zone.

Under standard operating conditions, starting the machine must not be possible while operators are inside the safety area.

The safety zones must be designed taking into account the minimum safety distance from the point where the risk is located. This distance must ensure that the hazardous area cannot be reached before the dangerous movement of the machine has been stopped by the ESPE.

The minimum distance calculations must meet the legal requirements in force at the place of use of the machine, referring to the state of the art defined by international and national standards.

According to the EN ISO 13855 Standard, the safety distance depends on the following factors:

- The Response Time of the ESPE (the time between the operator's detection and the opening of the OSSD).
- Machine stopping time (the time between the activation of the ESPE and the real stop of the dangerous movement of the machine)
- ESPE detection capability
- Type of approach: Parallel or Orthogonal to the Detection Zone
- Additional components to compensate reflection-based measurement errors
- Additional components to compensate reaching over: positioning of the scan plane, switching time between monitoring cases.
- Additional components depending on the type of application.

According to safety requirement EN ISO 13855, the general calculation for the minimum safety distance is given by the following formula:

$$S = (K \cdot T) + C$$

Where:

S = Minimum safety distance (mm)

K = Approach speed parameter (mm/s)

T = Total response time (ESPE + machine) (s)

C = Total additional distance (mm)

The **K** parameter depends on how quickly the operator approaches the machine. The operator must be prevented from inserting body parts inside the hazardous area before the safety device activates.

Minimum Safety Distance Calculations for Horizontal Applications



NOTE

The Minimum Safety Distance cannot exceed the nominal maximum limit of the Safety Zone for the scanner (5.5 m).

If the device is mounted with a detection angle of less than 30° with respect to the horizontal plane (floor), the application is considered horizontal (parallel approach).

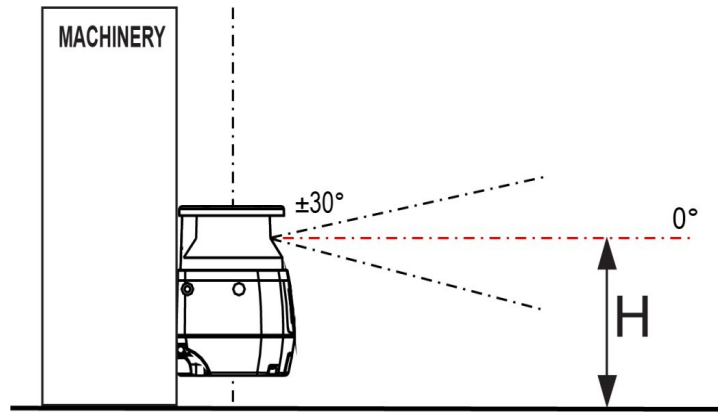

Figure 4 - Detection plane and approaching direction

The minimum safety distance S is given by:

$$S = (K \cdot T) + C; C_{MIN} = 850 \text{ mm}; H_{MIN} = 15(d - 50 \text{ mm})$$

Where:

S = Minimum safety distance (mm)

K = 1600 mm/s

T = t₁ + t₂

C = C_{HEIGHT} + C_{TOLERANCE} + C_{AMBIENT INTERF}

C_{MIN} = Lowest allowable C value

t₁ = Response time of the ESPE (s) (refer to "Response Time and Scan Cycle Setting" on page 66)

t₂ = Machine stopping time (s) (see machine specifications)

C_{HEIGHT} ≥ (1200 - 0.4H) mm

H = Height of the nominal scan plane with respect to the machine reference plane (floor) (mm)

H_{MIN} = Lowest allowable height of the detection zone (mm)

d = Detection capability of the ESPE (mm)

C_{TOLERANCE} = 100 mm

C_{AMBIENT INTERF} = environment interference conditions (mm) (refer to "Light Interference" on page 12 and "High Reflecting Background" on page 13)



NOTE

For applications with approach parallel to the detection plane, EN ISO 13855 defines the parameter K = 1600 mm/s.

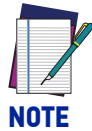

For horizontal applications the minimum safety distance also depends on the height of the nominal scan plane for the safety area. As the height H is reduced, the total additional distance C is increased.



If the scan plane is higher than 300mm, ensure that people cannot reach the hazardous area by crawling underneath the scan plane!



The device resolution should be set according to the height above ground of the scan plane; EN 13855 indicates that the calculation should be made using the formula $d = (H/15)+50$, where d = detection capability/resolution and H = height above ground of the scan plane.



In case of dynamic applications (e.g. AGVs), the laser scanner must be mounted at a max. scan plane height of 200mm. Additional distances must be taken into account considering the stopping distance and the characteristics of the vehicle.

Example of additional distance due to Height:

With a given machine stopping time of 0.4 s and a selected Laser Sentinel Response Time of 62 ms, detection capability = 70 mm and without any ambient interference:

$$S = [(1600 \text{ mm/s} \cdot (0.062 \text{ s} + 0.4 \text{ s})) + [(1200 \text{ mm} - 0.4H) + 100 \text{ mm} + 0 \text{ mm}]]$$

If $H = H_{\text{MIN}} = 300 \text{ mm}$ then $C_{\text{HEIGHT}} = 1080 \text{ mm}$

$$S = [739.2 \text{ mm}] + (1080 \text{ mm} + 100 \text{ mm} + 0 \text{ mm}) = 1919.2 \text{ mm}$$

If $H = 1000 \text{ mm}$ then $C_{\text{HEIGHT}} = 800 \text{ mm}$

$$S = [739.2 \text{ mm}] + (800 \text{ mm} + 100 \text{ mm} + 0 \text{ mm}) = 1639.2 \text{ mm}$$

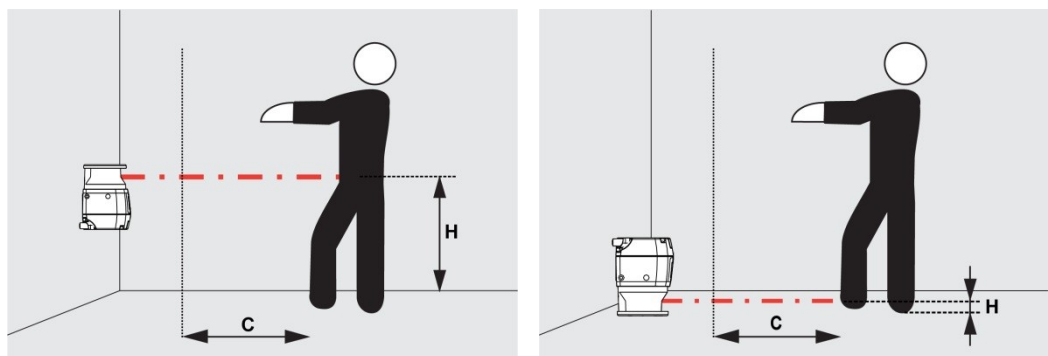

Figure 5 - Safety distance

Example of additional distance due to Ambient Interference:

From the previous example with a height of 300 mm, but in the presence of high reflective backgrounds and/or direct bright light:

Minimum safety distance

$$S - C_{\text{AMBIENT INTERF}} = [(1600 \text{ mm/s} \cdot (0.062 \text{ s} + 0.4 \text{ s})) + (1080 \text{ mm} + 100 \text{ mm}) = 1919.2$$

$C_{\text{AMBIENT INTERF}}$ (1919.2 ; detection capability = 70 mm) = 200 mm for “dust filter level” = high
 (refer to "Light Interference" on page 12 and "High Reflecting Background" on page 13)

$C_{\text{AMBIENT INTERF}}$ (1919.2 ; detection capability = 70 mm) = 87 mm for “dust filter level” = low
 (refer to "Light Interference" on page 12 and "High Reflecting Background" on page 13)

$$S = [(739.2)] + (1080 \text{ mm} + 100 \text{ mm} + 200 \text{ mm}) = 2119.2 \text{ mm for "dust filter level" = high}$$

$$S = [(739.2)] + (1080 \text{ mm} + 100 \text{ mm} + 87 \text{ mm}) = 2006.2 \text{ mm for "dust filter level" = low}$$

Minimum Safety Distance Calculations for Vertical Applications

For vertical applications, the previously indicated formula for the minimum safety distance can be used, but further considerations must be taken into account.

$$S = (K \cdot T) + C$$

Where:

- S = Minimum safety distance (mm)
- K = 1600 mm/s or 2000 mm/s (see Note)
- T = $t_1 + t_2$
- C = $8(d - 14 \text{ mm})$ or 850 mm (see Note)

t_1 = Response time of the Laser Sentinel (s) (see "Response Time and Scan Cycle Setting" on page 66)

t_2 = Machine stopping time (s) (see machine specifications)

d = Detection capability of the ESPE (mm)

Note:

K = 2000 mm/s if the calculated value of S is ≤ 500 mm

K = 1600 mm/s if the calculated value of S is > 500 mm

C = $8(d - 14)$ mm for devices with detection capability $d \leq 40$ mm

C = 850 mm for devices with detection capability $d > 40$ mm

Body parts protection (reference contour)

When the safety laser scanner is used for body parts detection, in applications where the approach angle exceeds $\pm 30^\circ$ to the detection plane, it shall monitor a physical boundary. Reference boundary monitoring requires a comparison of the reference distance and the distance measured by the device.

The reference distance is the distance between the safety laser scanner and each point of the boundary (e.g. a wall) configured at the first installation. The stated detection capability shall be in the range from 30 mm to 70 mm. If the reference boundary is the edge of the safeguarded aperture, the tolerance zone should not exceed half of the stated detection capability (see also dimension a). Otherwise, it should be protected by another means, such as fixed guarding.

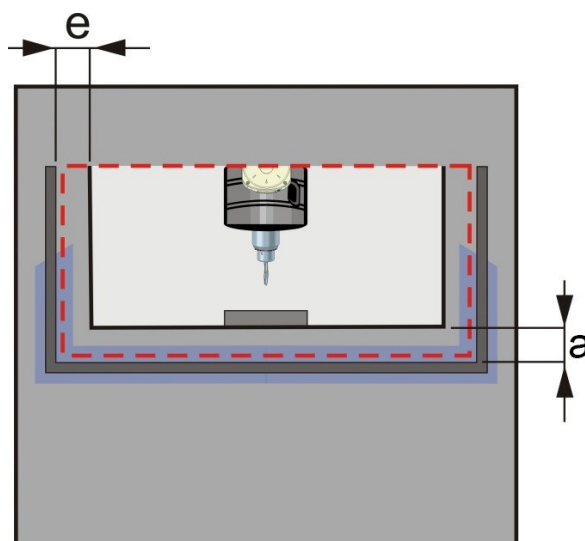

Figure 6 - Reference distances

Access protection

If the reference boundary is the edge of the safeguarded aperture, the tolerance zone must not exceed 100 mm.

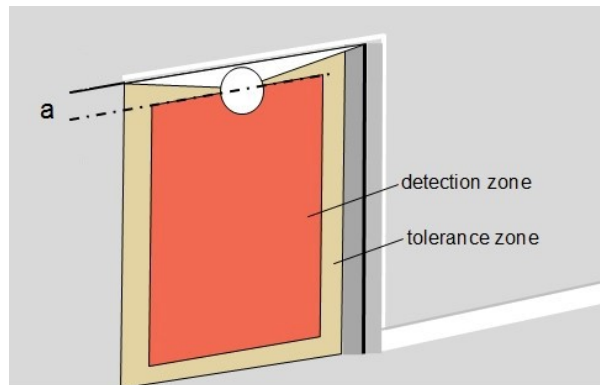

Figure 7 - Access protection

Figure 7 shows the use of Laser Sentinel as a whole-body safety device where the reference boundary is the edge of the safeguarded aperture. In this application we have to take into account the tolerance zone of the safety laser scanner and the dimensions of a possible unprotected zone due to the physical installation (a), taking additional precautions by another means, for example additional mechanical protection.

Minimum Safety Distance Calculations for Mobile Applications

Laser Sentinel can be installed on a mobile machine, e.g. an AGV, in order to constantly monitor the absence of persons along the driving direction of the vehicle, detecting their presence in the safety zone parallel to the direction of approach.

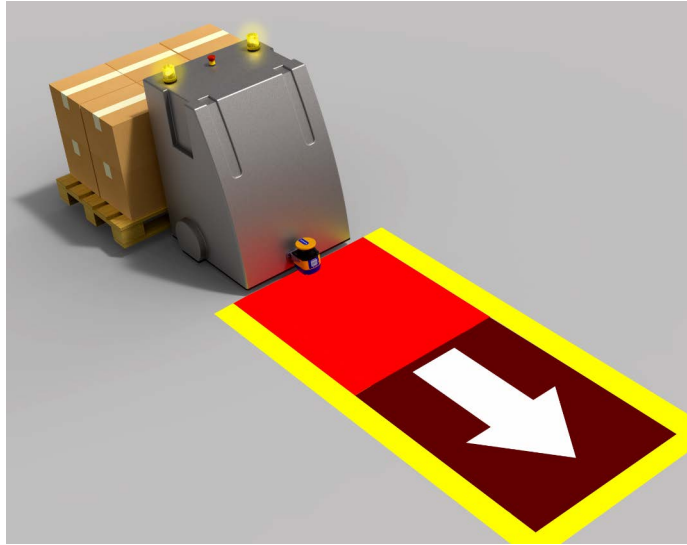

Figure 8 - Safety zone (red) for AGV protection



NOTE

In the following calculation examples, only the speed of the vehicle is considered and not the speed of a moving person. It is assumed that the person stops recognizing the danger.



NOTE

If the application involves a change in the shape or size of the safety zone, considerations regarding the size of the safety zone should be extended to all cases. If the speed changes in these cases, calculations should be made using the maximum achievable speed in each case.



NOTE

It is recommended to use a resolution of 70 mm or less to ensure that the operator's ankle is detected.



NOTE

It is recommended to place the scanning plane at a height of no more than 150 mm above the floor H and never more than 200 mm to ensure that a person lying on the floor is detected.



WARNING

The stopping distance of a vehicle does not increase proportionally with speed, but with the square of the speed.

In mobile applications, the safety zone must be long enough to ensure that the vehicle stops before coming into contact with the detected person.

When **calculating the minimum length**, possible environmental interference described in "Light Interference" on page 12 and "High Reflecting Background" on page 13 must be taken into account. In the following formulas, it will be indicated with $C_{ENVIRON.INTERF}$.

In the case of vehicles, it is also necessary to consider an increase (CF) due to the length of the foot in relation to the point of detection. In first approximation, this increase is 150 mm, but can be reduced depending on the width of the aperture (A) between the vehicle and the floor, according to the following graph:

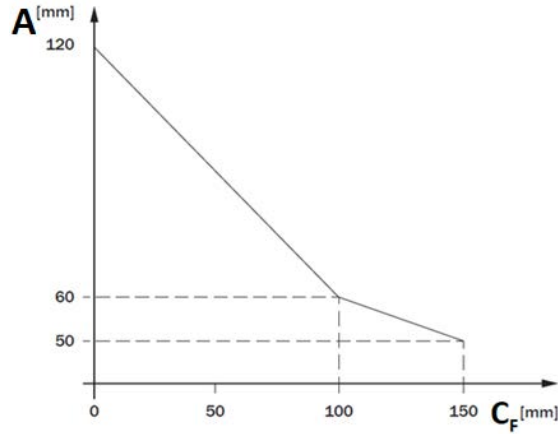

Below is an example of calculation of the minimum length (L) for the safety zone:

$$L = D_S + C_{TOLERANCE} + C_{ENVIRON.INTERF} + C_F + C_D$$

Where:

D_S = Stopping distance

$C_{TOLERANCE}$ = Laser Sentinel measurement tolerance (100 mm)

$C_{ENVIRON.INTERF}$ = Increase for measurement errors due to optical interference or reflections (200 mm)

C_F = increase due to lack of aperture between AGV and floor (150 mm)

C_D = possible increase due to the reduced braking force of the vehicle

The stopping distance D_S is given by the sum of

$$D_S = D_B + D_{S1} + D_{S2}$$

Where:

D_B = Braking distance (depending on vehicle characteristics, load and floor characteristics and condition)

D_{S1} = Space traveled during vehicle controller response time = (controller response time) * Speed

D_{S2} = Space traveled during Laser Sentinel response time = $T * Speed$

T = response time of the Laser Sentinel, as set by the user according to the number of scans (see "Response Time and Scan Cycle Setting" on page 66).

Also when **calculating the minimum width** of the safety zone, increases must be taken into account to compensate for possible environmental interference and the increase due to the lack of aperture between the AGV and the floor.

Below is an example of calculation of the minimum width (W) for the safety zone:

$$W = W_{\text{VEHICLE}} + 2 * (C_{\text{TOLERANCE}} + C_{\text{ENVIRON.INTERF.}} + C_F)$$

Where:

W_{VEHICLE} = Width of the vehicle, including its load

$C_{\text{TOLERANCE}}$ = Laser Sentinel measurement tolerance (100 mm)

$C_{\text{ENVIRON.INTERF.}}$ = Increase for measurement errors due to optical interference or reflections (200 mm)

C_F = increase due to lack of aperture between AGV and floor (150 mm)



NOTE

If Laser Sentinel is not installed in the center of the vehicle, the safety zone should be drawn asymmetrically so that the protruding parts of the safety zone are located to the right and left of the vehicle.

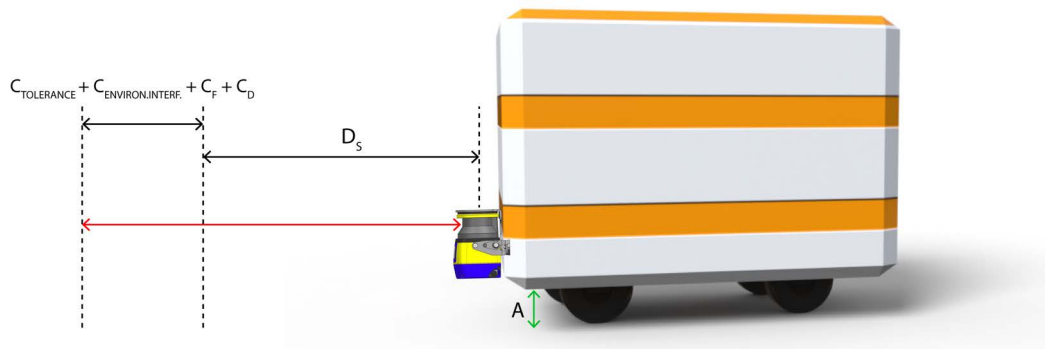

UNPROTECTED ZONE

The unprotected zone (a) must be small enough to ensure that a person cannot approach the danger zone or stay between the danger zone and the safety zone without being detected. This can require additional mechanical protection.

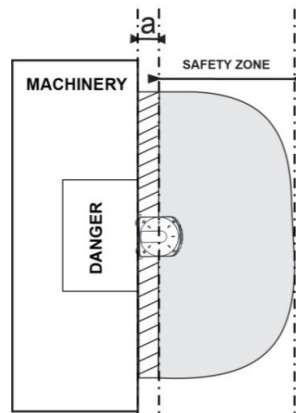

Figure 9 - Safety Distance Example (Top View)

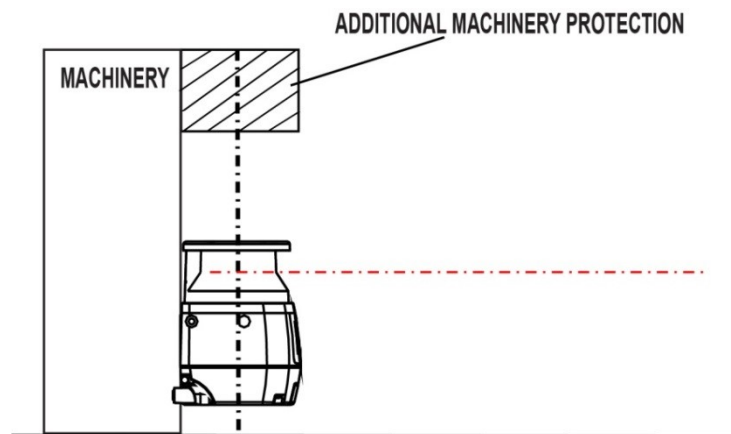
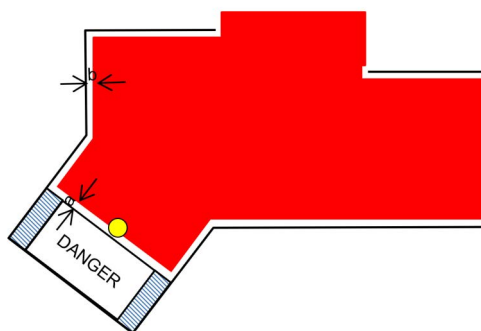

Figure 10 - Safety Distance Example (Side View)

DISTANCE TO WALL



NOTE

The Safety Zone must maintain a tolerance of at least 40 mm from any wall or fixed object (a and b in the image above). This value is generally enough to guarantee normal operation, however according to the real reflectance characteristics of the wall, a higher value may be necessary. The Teach In feature in DLSentinel automatically applies a tolerance of 100 mm. This can be changed manually if necessary. Verify the correct placement of the Safety Zone during the initial configuration before commissioning.

DEVICES ORIENTATION

The installation may require different safety laser scanners in the same location. In this state, it is possible that the devices interfere with each other and the OSSD might to the OFF-state.

Specific mounting requirements must be followed to prevent a dangerous failure.

- Tilt the Laser Sentinel so that the scanning plane does not enter the output window of any other scanner.

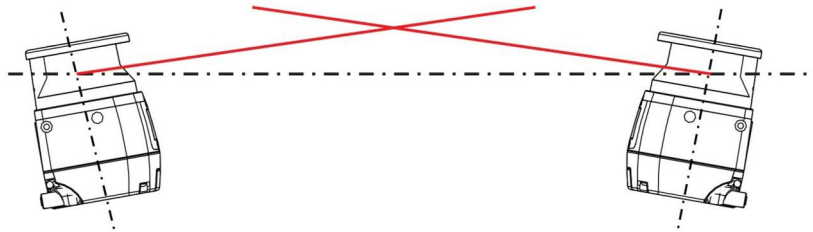

Figure 11 - Scanner mounted ad different scanning angles

- Mount the devices at different heights so that there is an offset equal to or greater than the height of the scanner output window.

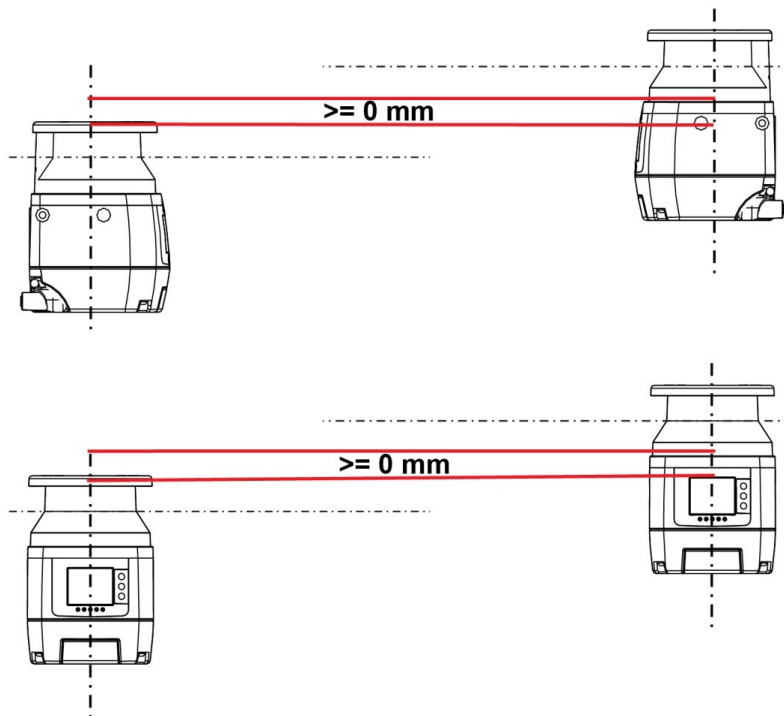

Figure 12 - Scanners mounted ad different scanning heights

- Set the devices to different response time.

- Install a shielding plate to block scanning signal interference.

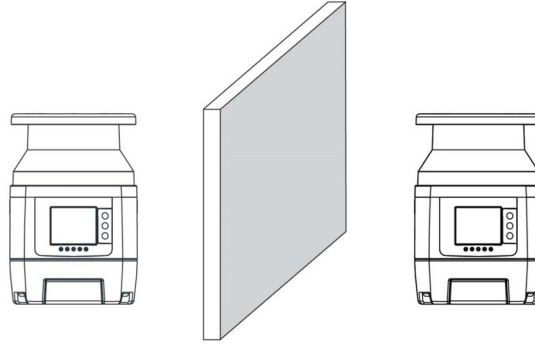

Figure 13 - Shielding plate between scanners

- Make the safety area smaller.

CHECKS AFTER FIRST INSTALLATION

After the initial installation and before starting up, machine test operations must be carried out by qualified personnel, or under the strict supervision of the person in charge of the machine safety.

The checks to carry out are listed below:

- The response time at machine STOP, including the ESPE and machine response times, must be included in the limits defined in the calculation of the safety distance (refer to "Response Time and Scan Cycle Setting" on page 66).
- The safety distance between the dangerous parts and ESPE must comply with the requirements indicated in "Device Positioning and Minimum Distance Calculations" on page 15. The safety zone must be designed so that the approach towards any dangerous point of the machine can be possible only passing through it, and the distance that a person is obliged to cover must be longer than the minimum safety distance.
- A person must not remain between safety zone and dangerous parts of the machine undetected.
- Access to the dangerous areas of the machine must not be possible from any unprotected area.
- Verify the correspondence of all the accessory functions, activating them in the different operating conditions.
- The machine builder must define the type and frequency for the checks of the machine and its safety system based on the risk assessment. Regular checks are recommended in order to prevent external influences or modification (such as damage or tampering).
- Safety checks must be carried out at least annually by qualified personnel only and must be documented in a traceable manner.
- To test the detection capability of the device(s), the user can use a suitable test piece, e.g. an optically dark, opaque cylinder. The effective diameter should match the configured resolution. Datasensing suggests adopting the following procedure:

Place the test piece on several points at the edges of the safety area. The safety laser scanner must detect the test piece at each position and go to STOP. The number and location of sites where the test is performed must be chosen so that undetected access to the hazardous area is not possible.

Do not attempt to insert the test piece into dangerous parts of the machine located in the safety area.

Remove the test piece from the controlled area and check that:

- the machine automatically restarts (in case of Automatic restart), OR
- the machine restarts only after receiving the restart command (in case of Manual restart).

The following pictures are examples of detection capability test (the red areas correspond to the configured Safety Areas).

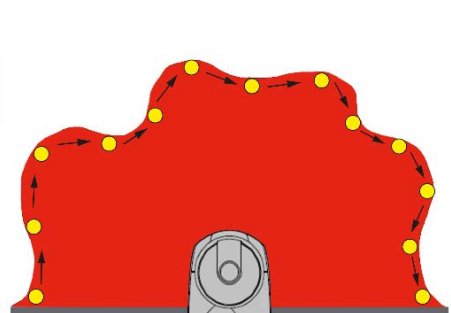
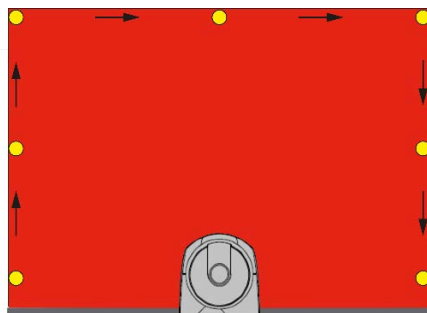

- Power off the safety laser scanner(s). Check that both OSSD outputs automatically switch to OFF status and make sure that the machine cannot start until power is re-applied.
- If the check session reveals hypothetical faults, the machine must be shut down immediately to allow further checks on the electrical and mechanical installations by qualified personnel.
- The risk evaluation of the machine may determine that further or more frequent checks are required depending on the application conditions.
- Together with the regular checks, it is recommended to perform a visual check of the machine and the safety device.
- The machine builder must check the display and the status LED: if a machine is switched ON, and at least one LED below the safety laser scanner's display is not functioning properly, it may be a failure.
- Test the device by triggering the safety function, e.g. the machine builder can observe the reaction of the OSSDs.
- For all device applications: check if the Laser Sentinel shows the interruption of the safety field using the LEDs and/or the display.
- Horizontal application: stop the safety field using an appropriate test piece and check if the machine stops.
- Activate a protective field, which is interrupted by at least one test piece and check the expected reaction.
- If the check reveals a fault, the machine must be shut down immediately. In this case, the mounting and electrical installation of the safety laser scanner must be checked by qualified personnel.
- In case of Manual Restart, the Restart button must be placed outside the dangerous area. The operator must have full view of the dangerous area to activate the Restart button.

CHAPTER 5

MECHANICAL MOUNTING

For mechanical mounting, the Laser Sentinel has two different procedures depending on the operation necessities. The two mounting possibilities are:

- direct mounting, OR
- angle adjustment bracket mounting (if the pitch and the roll angles need to be adjusted).

Optionally, the protection bracket can be added to applications using the angle adjustment brackets.



NOTE

Required tool adjustable torque driver with 3 mm hex bit.

DIRECT MOUNTING

The device has two M5 threaded holes on the back and four M5 threaded holes on the side.

For direct mounting, use both M5 threaded holes in the back or all four M5 threaded holes on the two sides, considering the following values:

- M5 on the back (tightening torque 2.3 - 5.5 Nm), maximum depth of thread engagement 9.5 mm.
- M5 on the side (tightening torque 2.3 - 3 Nm), maximum depth of thread engagement 8 mm.



NOTE

For direct mounting on the sides, if the wall or panel obstructs the output window, this plane cannot be used for safety zone monitoring. The safety zone must adhere to the minimum distance to wall value given in "Distance to Wall" on page 25.

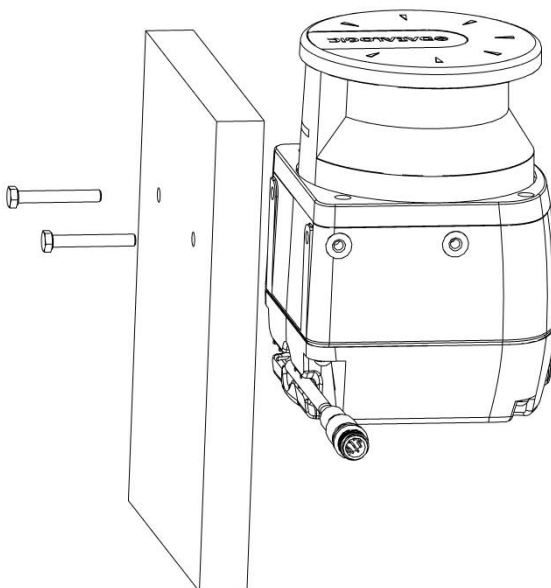

Figure 1 - Direct Mounting



NOTE

The M5 UNI 5933 screws used for mounting the brackets to a wall are not supplied in the SLS bracket mounting kits; they must be supplied by the user.



NOTE

If the direct mounting procedure to the back is chosen, it is not possible to add the protection bracket to the device.

PROTECTION BRACKET MOUNTING (SLS-BRACKET-C) (OPTIONAL)

The protection bracket is an optional accessory, which provides protection to the device if it is located in a specific work environment where the device may be hit by falling objects or subject to collision.

Fasten the Protection Bracket **(1)** on the back of the Laser Sentinel, by using two M5 screws **(2)** (Maximum 2.9-3.1 Nm Torque).



NOTE

The SLS-BRACKET-C must be mounted on the device before the other fastening accessories.

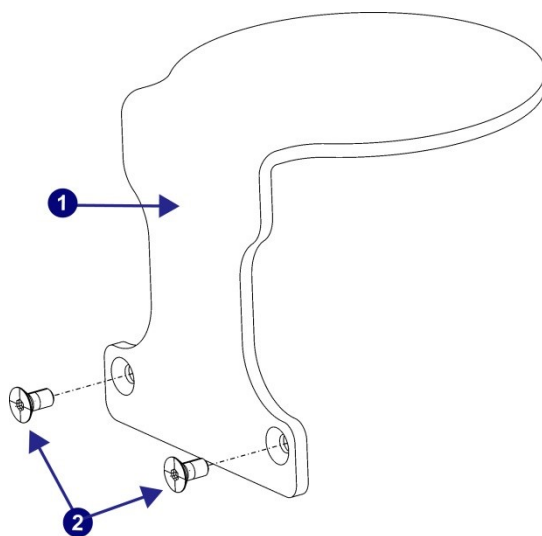

Figure 2 - Protection Bracket Mounting

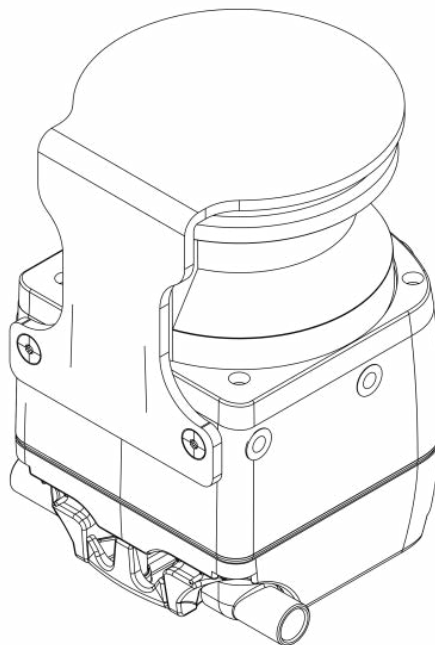

Figure 3 - Protection Bracket Mounted to Scanner

ANGLE ADJUSTMENT BRACKET MOUNTING

First, provide two M5 holes with 73 mm spacing on the intended wall or mounting surface.



NOTE

The M5 UNI 5933 screws used for mounting the brackets to a wall are not supplied in the SLS bracket mounting kits; they must be supplied by the user.

Pitch and Roll Angle Adjustment Bracket (SLS-BRACKET-A)

The bracket system (10) is partially assembled.

1. Mount the roll adjustment bracket (4) to the wall or panel by inserting two M5 UNI 5933 screws (not included), and tighten them, repeatedly alternating between one and the other, until they are completely tight.
2. After removing the M4 screws and washers (5) from the roll adjustment bracket (4), use them to assemble the support bracket (10) to the roll adjustment bracket (4).



NOTE

Still, do not tighten the M4 Roll Adjustment screws for the roll angle (5).

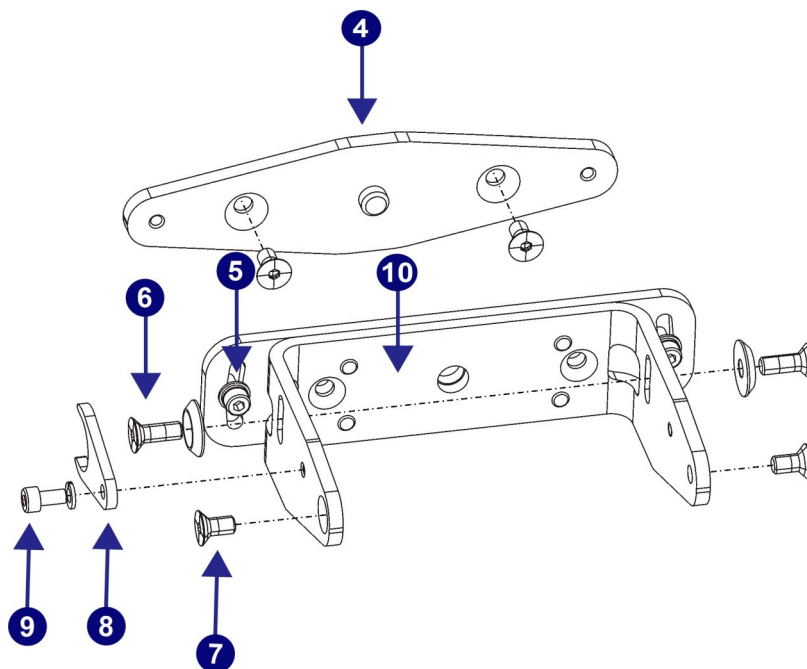

Figure 4 - Pitch and Roll Angle Adjustment Bracket

Pitch Angle Adjustment Bracket (SLS-BRACKET-B)

Mount the pitch adjustment bracket (3) to the wall or panel by inserting two M5 UNI 5933 screws (not included), and tighten them, repeatedly alternating between one and the other, until they are completely tight.

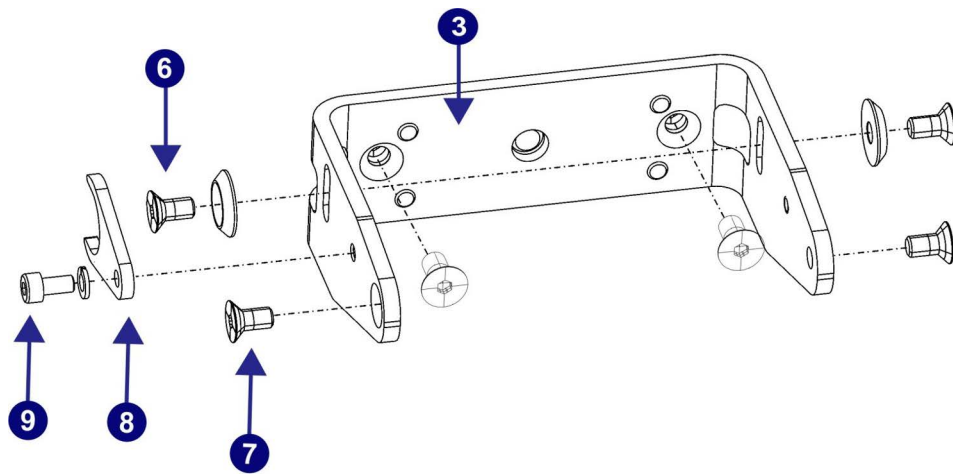
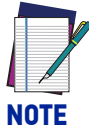

Figure 5 - Pitch Angle Adjustment Bracket

SCANNER MOUNTING AND PITCH ANGLE ADJUSTMENT



Make sure to use the specific Torques indicated for the different procedures to avoid damaging the device permanently.



The pitch angle adjustment is a procedure related to both SLS-BRACKET-A and SLS-BRACKET-B.

The Positioning Memory Bracket (one piece) **(8)** saves the inclination angle set for the installation. This allows for quick installation without further mechanical adjustments if it is ever necessary to replace the unit.

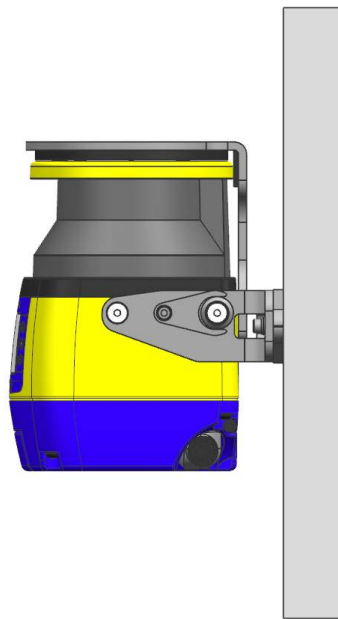

Figure 6 - Scanner Mounting and Pitch Angle Adjustment

To mount the device with 90° vertical inclination:

1. Mount the Positioning Memory Bracket **(8)** with the M4 screw (and washer) **(9)** to the main bracket **(3)** but do not tighten it.
2. Align the Positioning Memory Bracket with the center of the main bracket slot, then tighten the M4 screw **(9)** (1.5-1.6 Nm Torque).
3. Mount the scanner to the main bracket using the M5 x 14 Pitch Adjustment Screws (with washers) **(6)** and the M5 x 10 Scanner Fastening Screws **(7)**. Tighten all four screws (2.9 - 3.1 Nm Torque).

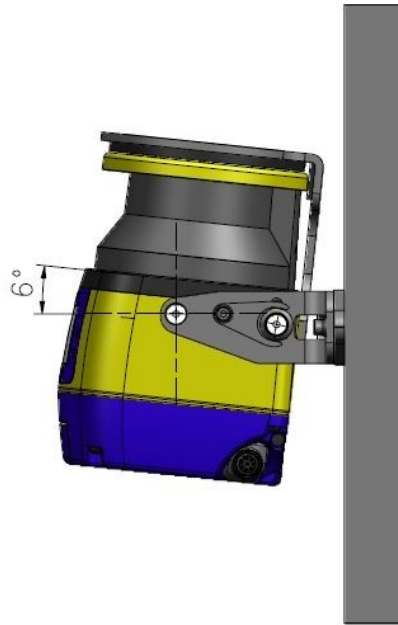

Figure 7 - Scanner Mounting and Pitch Angle Adjustment

To place a device with a specific pitch angle:

- Screw without tightening the M5 Scanner Fastening Screws **(7)**, the M5 Pitch Adjusting Screws **(6)** and the Positioning Memory Bracket **(8)** with the M4 screw **(9)**.
- Rotate the device to reach the desired pitch angle within the allowed range (+/- 6°).
- Tighten the M5 Scanner Fastening Screws **(7)** and then the M5 Pitch Adjusting Screws **(6)** (2.9 - 3.1 Nm Torque).
- In the end, tighten the Positioning Memory Bracket M4 screw **(9)** (1.5 – 1.6 Nm Torque).

ROLL ANGLE ADJUSTMENT

**NOTE**

The roll angle adjustment is a procedure related only to SLS-BRACKET-A.

Rotate the brackets to reach the desired roll angle within the allowed range ($\pm 8.5^\circ$) and then tighten the M4 Roll Adjusting Screws (5) (1.4 - 1.5 N/m Torque).

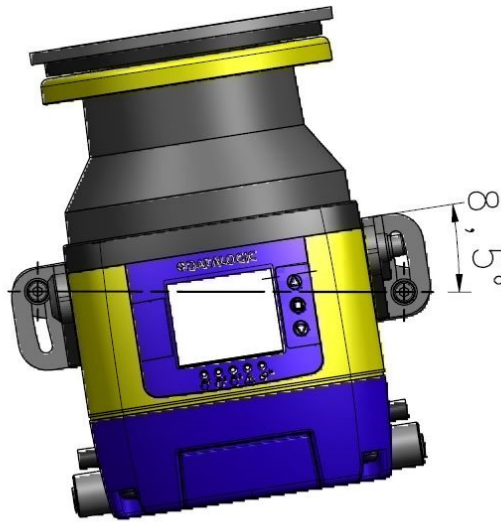

Figure 8 - Roll Angle Adjustment

MEMORY GROUP UNMOUNTING FOR CABLE CONNECTION

Follow the Master model's memory group unmounting procedure to connect the M12 8/12/17-pole connector (according to model) for machine interface.



Adjustable torque driver with 2.5 mm hex key.

NOTE

1. Orient the device with the optic head pointed downward to access the underside of the device (connectors location).



2. Unscrew the two M3 screws of the protective cover, then remove it.



The protective cover is tightened with captive screws, so the operator only has to loosen the screws to extract the cover from the device.

NOTE

3. Loosen the two M3 fixing screws of the memory group and disconnect the memory group by extracting it from the scanner.



**NOTE**

The memory group is tightened to the scanner with captive screws, so the operator only needs to loosen them to extract it from the scanner.

4. Connect the power M12 8/12/17-pole connector (according to model) **making sure the power is OFF!**



5. Insert the memory group and tighten the two M3 fixing screws (Torque 1 N/m).
6. Replace the protective cover, screw and tighten the two M3 screws (Torque 0.5 N/m).



SAFETY INFORMATION REGARDING MOUNTING

Make sure that the protection level assured by the Laser Sentinel is compatible with the danger level of the working machine, according to EN ISO 13849-1 or EN 62061.



NOTE

For further information refer to Chapter 4, Installation.

Dangerous Machine Status:

- Make sure that the machine is OFF (not operating) during mounting, electrical installation, and commissioning.
- Make sure that the safety laser scanner outputs do not affect the machine during mounting, electrical installation, and commissioning.
- The device mounting and connections must be carried out by qualified personnel only, according to the indications included in the specific sections (refer to [Chapter 5, Mechanical Mounting](#) and [Chapter 6, Electrical Connections](#)) and in the applicable standards.
- The safety laser scanner must be securely placed in such a position that access to the dangerous zone is not possible without passing throughout the safety area. This must be done according to the indications included in the specific section (refer to [Chapter 4, Installation](#)) and in the applicable standards.
- Please carefully read the instructions for correct functioning before powering the device.

Hazard due to safety device malfunctioning:

- If unsuitable brackets are used, the device may be damaged. Only use Datasensing approved brackets for mounting.
- Personnel or parts of the body may not be detected in case of non-observance.
- Take appropriate measures for vibration damping if vibration and shock specifications exceed the values and test conditions specified in [Appendix A, Technical Data](#).
- Do not carry out any repairs to the device components.
- Do not open the device components if the document procedures are not followed.
- The Laser Sentinel optics cover is an optical component. Make sure that the optics cover does not become dirty or scratched during mounting.
- Avoid fingerprints or other contamination on the optics cover.
- Check the integrity of all parts and components.
- If the components show damage, contact Datasensing.
- Install the device so that the status indicators are clearly visible.
- Make sure to observe the minimum safety distances calculated for your machine.
- Install the safety laser scanner so that it is not possible to crawl beneath, climb over or stand behind the safety area.
- Protect the device from dirt and damage by mounting it properly.
- The device view must not be restricted or obstructed (refer to "[Installation Precautions](#)" on page 10).
- The safety laser scanner must be correctly aligned, even during mounting: if the safety laser scanner is intended to monitor an area of 275 ° on a corner, the safety laser scanner may be mounted rotated by a maximum of 2.5 ° about the vertical axis.

CHAPTER 6

ELECTRICAL CONNECTIONS

LASER SENTINEL STAND ALONE MODEL CONNECTORS

The Laser Sentinel Stand Alone model includes:

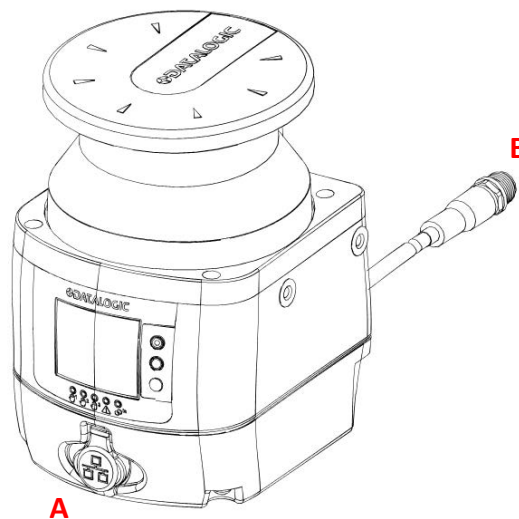

- A M12 4-pole connector** (Programming and monitoring of safety laser scanner with Graphic User Interface)
- B M12 8-pole connector** (Machine interface: power supply and inputs/outputs)

Machine Interface Connections

The Laser Sentinel Stand Alone model has one OSSD pair and three signals programmable as inputs and outputs. These signals allow the user to configure the device with several functions:

- the detection of a person or an object in the Warning Zone,
- the switching of the detection areas by employing external signals (Area Switch),
- the restart of the device caused by the OSSD Off-status (Restart),
- restoring the device after a failure condition (Reset),
- the automatic deactivation of the safety status on the whole safety zone (Muting),
- the Single line pattern Muting Override used to force the safety function deactivation whenever it is necessary to restart the machine.

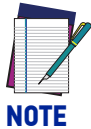

For further information about the device functions, refer to Chapter 8, Functions.

NOTE



Make sure that the signals are aligned with the pin features and their specific function. In addition, they must be correctly connected to the external device.

NOTE

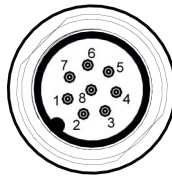

Figure 1 - Connector (M12, 8-pole Male)

CATEGORY	TYPE	COLOR	DESCRIPTION	PIN OUT
POWER	POWER SUPPLY	BROWN	24Vdc	2
	GND_ISO	BLUE	0 V	7
INPUT/OUTPUT	MULTI IN/OUT	GREEN	Selectable by GUI	3
	MULTI IN/OUT	YELLOW	Selectable by GUI	4
	MULTI IN/OUT	WHITE	Selectable by GUI	1
SAFETY OUTPUTS	OSSD 1/1	GRAY	Safety Output	5
	OSSD 1/2	PINK	Safety Output	6
OTHER	F_EARTH	RED	Functional Earth	8

The **Multi In/Out** is a Pin that can be configured either as input or output.

TYPE	FUNCTION	CONNECTION
MULTI-IN	RESTART/RESET	
	AREA SWITCH	
	OVERRIDE (Single line pattern)	
	MUTING 1 MUTING 2	
	MUTING ENABLE	
MULTI-OUT	WARNING	
	MUTING LAMP	
OSSD	OSSD 1/1 OSSD 1/2	

MASTER SLAVE SYSTEM CONNECTION

The Laser Sentinel series includes various models that differ in some features, such as electrical configuration and connection type.

There are two main safety laser scanner models: the Master (that can be used individually or to run other slave devices) and the Slave (that must be connected to a Master and has only a particular connection to be connected to its Ethernet network).

On one side, the device is equipped with M12 connector socket, on the other side, the operator must employ free wires in compliance with the Laser Sentinel pinout colors.

Datasensing provides the wires in compliance with the regulations and standards for a safe use of the Laser Sentinel (refer to [Appendix C, Accessories](#)).

The Master (see [Figure 1 on page xiii](#)) includes:

- M12 8-pole connector
- M12 12-pole connector
- M12 17-pole connector
- M12 4-pole rotatable side connector (LAN connection)
- M12 8-pole rotatable side connector (for the connection to the Slave network)

The Slave (see [Figure 2 on page xiv](#)) includes:

- M12 8-pole rotatable side connector (Input Port)
- M12 8-pole rotatable side connector (Output Port)



NOTE

For power and I/O cables (8 poles, 12 poles, and 17 poles), you must unmount the memory group as described in "Memory Group Unmounting for Cable Connection" on page 38.

MASTER CONNECTION

The Master model includes a configurable set of input and outputs that have a specific purpose and it depends on the selected topology and pin configuration.

Through the GUI, the user can choose the type of configuration. The operator must follow the indications for the type of pin selected and the safety standards.



NOTE

Input and output connected to the Laser Sentinel must be aligned with the features of the used pin.



NOTE

8-pole and 12-pole connectors cannot be used together, but just individually according to application needs.

Master M12 8-Pole Connector

The Master M12 8-pole model has various pin typologies. The features of all the electrical pins are showed in the chart below.

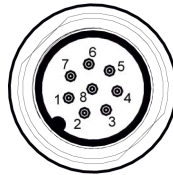

Figure 2 - Connector (M12, 8-pole Male)

CATEGORY	TYPE	COLOR	DESCRIPTION	PIN OUT
POWER	POWER SUPPLY	BROWN	24Vdc	2
	GND_ISO	BLUE	0 V	7
INPUT/OUTPUT	MULTI IN	GREEN	Selectable by GUI	3
	MULTI IN	YELLOW	Selectable by GUI	4
	MULTI IN/OUT	WHITE	Selectable by GUI	1
SAFETY OUTPUTS	OSSD 1/1	GRAY	Safety Output	5
	OSSD 1/2	PINK	Safety Output	6
OTHER	F_EARTH	RED	Functional Earth	8

The **Multi In/Out** is a Pin that can be configured either as input or output.

TYPE	FUNCTION	CONNECTION
MULTI-IN	RESTART/RESET	
	AREA SWITCH	
	OVERRIDE (Single line pattern)	
	MUTING 1 MUTING 2 MUTING ENABLE	
MULTI-OUT	WARNING	
	MUTING LAMP	
OSSD	OSSD 1/1 OSSD 1/2	

Master M12 12-Pole Connector

The M12 12-pole Master model has various pin typologies. The features of all the electrical pins are showed in the chart below.

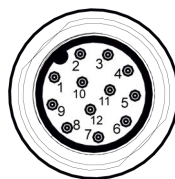

Figure 3 - Connector (M12, 12-pole Male)

CATEGORY	TYPE	COLOR	DESCRIPTION	PIN OUT
POWER	POWER SUPPLY	BROWN	24Vdc	1
	POWER SUPPLY	GREEN	24Vdc	4
	GND_ISO	BLUE	0 V	2
	GND_ISO	YELLOW	0 V	6
INPUT	MULTI IN	WHITE	Selectable by GUI	3
INPUT/OUTPUT	MULTI IN/OUT	BLACK	Selectable by GUI	7
	MULTI IN/OUT	RED	Selectable by GUI	9
	MULTI IN/OUT	VIOLET	Selectable by GUI	10
	MULTI IN/OUT	GRAY/PINK	Selectable by GUI	11
SAFETY OUTPUTS	OSSD 1/1	GRAY	Safety Output	8
	OSSD 1/2	PINK	Safety Output	5
OTHER	F_EARTH	RED/BLUE	Functional Earth	12



NOTE

In case of configurations with one or more Slave devices, both POWER SUPPLY and GND_ISO cables must be connected.

Multi In (8-pole and 12-pole models)

The Multi In are input signals configurable depending on the safety application needed. These input signals can have the following functions for 8-pole 12-pole models:

TYPE	FUNCTION	DESCRIPTION	CONNECTION
MULTI IN	RESTART	Restarts the device following OSSD Off-status	
	RESET	Restores the device after a failure condition	
	RESTART 1 / RESET	Restarts or restores the device	
	AREA SWITCH 1	Switches the detection areas by employing external signals	
	AREA SWITCH 2		
	AREA SWITCH 3		
	AREA SWITCH 4		
	AREA SWITCH 5		
	MUTING ENABLE 1	If it is a high level, the Muting feature is enabled, and Muting will be performed	
	MUTING 11	Automatically deactivates the safety status on the whole safety zone	
	MUTING 12		

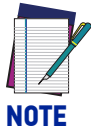

Make sure that the signals are aligned with the pin features and their specific function. In addition, they must be correctly connected to the external device.

Multi Out (8-pole and 12-pole models)

The Multi Out are output signals, configurable depending on the safety application needed. These output signals can be configured for the 8-pole and 12-pole models:

TYPE	FUNCTION	DESCRIPTION	CONNECTION
MULTI OUT	MUTING LAMP 1	Active Muting function signal. Connect LED lamp providing it with 24 Vdc	
	WARNING 1	Outputs for detections in the warning area	
	WARNING 2		
	ALARM 1	Clean window	
	ALARM 2	Device error	
NO FUNCTION	not used		

Multi In/Out (8-pole and 12-pole models)

The Multi In/Out are signals that can be configured both as inputs and outputs. Laser Sentinel allows the operator to connect from one to three OSSD pairs; it is possible to assign to the same electrical pin input and output signals defined as Multi In or Multi Out.

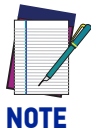

The additional OSSDs are aligned to the main outputs OSSD11 and OSSD12 requirements (OSSD11 and OSSD12 are not configurable). If a Multi Out pin is selected, a second signal linked to it will be automatically configured (EN 61496). This will ensure that the two Multi Out outputs will be used for the same purpose.

TYPE	FUNCTION	DESCRIPTION	CONNECTION
MULTI IN/OUT	MULTI IN	MULTI IN/OUT inputs can be configured as MULTI IN inputs	
	MULTI OUT	MULTI IN/OUT inputs can be configured as MULTI OUT inputs	

Master M12 17-Pole Connector

The M12 17-pole Master model has various pin typologies. The features of all the electrical pins are showed in the chart below.

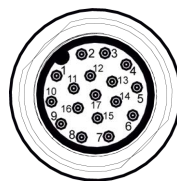

Figure 4 - Connector (M12, 17-pole Male)

CATEGORY	TYPE	COLOR	DESCRIPTION	PIN OUT
POWER	POWER SUPPLY	BROWN	24Vdc	1
				10
				11
	GND_ISO	BLUE	0 V	2
				3
				12
INPUT	MULTI IN	WHITE	Selectable by GUI	14
	MULTI IN	BLACK	Selectable by GUI	7
	MULTI IN	ORANGE	Selectable by GUI	6
	MULTI IN	VIOLET	Selectable by GUI	17
OUTPUT	MULTI OUT	GREEN	Selectable by GUI	4
	MULTI OUT	YELLOW	Selectable by GUI	15
INPUT/OUTPUT	MULTI IN/OUT	WHITE/ BLACK	Selectable by GUI	5
	MULTI IN/OUT	RED	Selectable by GUI	9
SAFETY OUTPUTS	OSSD 1/1	GRAY	Safety Output	13
	OSSD 1/2	PINK	Safety Output	8
OTHER	F_EARTH	YELLOW/ GREEN	Functional Earth	16

Master M12 17+8 Pole Connector

The M12 17-pole connector can be associated to the M12 8-pole connector for additional functions, e.g. encoders.

The features of all the electrical pins of the additional 8-pole connector are showed in the chart below. For the electrical pins of the 17-pole connector, see "[Master M12 17-Pole Connector](#)" on page 47.

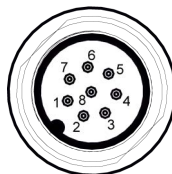

Figure 5 - Connector (M12, 8-pole Male)

CATEGORY	TYPE	COLOR	DESCRIPTION	PIN OUT
SPEED INPUT	MULTI IN SPEED	GRAY	A encoder 1. Selectable by GUI	8-5
	MULTI IN SPEED	PINK	B encoder 1. Selectable by GUI	8-6
	MULTI IN SPEED	YELLOW	A encoder 2. Selectable by GUI	8-4
	MULTI IN SPEED	RED	B encoder 2. Selectable by GUI	8-8
INPUT	MULTI IN	GREEN	Selectable by GUI	8-3
	MULTI IN	BLUE	Selectable by GUI	8-7
	MULTI IN	BROWN	Selectable by GUI	8-2
	MULTI IN	WHITE	Selectable by GUI	8-1

Multi In (17 pole and 17+8 pole models)

The Multi In are input signals configurable depending on the safety application needed. These input signals can have the following functions:

TYPE	FUNCTION	DESCRIPTION	CONNECTION		
MULTI IN	SHUT OFF	Enables the Shut Off function for energy saving			
	EDM 1	Enables the External Device Monitoring			
	EDM 2				
	RESTART 1	Restarts the device following OSSD Off-status			
	RESTART 2				
	RESET	Restores the device after a failure condition			
	RESTART 1/ RESET	Restarts or restores the device			
	RESTART 2/ RESET				
	RESTART 1/ RESET/EDM 1	Restarts or restores the device, or enables the EDM function			
	RESTART 2/ RESET/EDM 2				
	AREA SWITCH 1	Switches the detection areas by employing external signals			
	AREA SWITCH 2				
	AREA SWITCH 3				
	AREA SWITCH 4				
	AREA SWITCH 5				
	AREA SWITCH 6				
	AREA SWITCH 7				
	AREA SWITCH 8				
	OVERRIDE 11 (PULSED)	Enables the override function (either pulsed or level)			
	OVERRIDE 11 (LEVEL)				
	OVERRIDE 12 (LEVEL)				
	OVERRIDE 21 (PULSED)				
	OVERRIDE 21 (LEVEL)				
	OVERRIDE 22 (PULSED)				
	MUTING ENABLE 1			If it is a high level, the Muting feature is enabled, and Muting will be performed	
	MUTING 11			Automatically deactivates the safety status on the whole safety zone	
	MUTING 12				
	MUTING ENABLE 2	If it is a high level, the Muting feature is enabled, and Muting will be performed			
	MUTING 21	Automatically deactivates the safety status on the whole safety zone			
	MUTING 22				
NO FUNCTION	not used				

Multi In Speed (17+8 pole models)

The Multi In Speed are input signals configurable depending on the safety application needed. If the application uses encoders, all encoder inputs are employed (ENCODER 11, ENCODER 12, ENCODER 21, ENCODER 22).

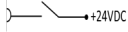
TYPE	FUNCTION	DESCRIPTION	CONNECTION
MULTI IN SPEED	ENCODER 11	Enables the encoder function.	
	ENCODER 12		
	ENCODER 21	Both couples are automatically activated.	
	ENCODER 22		
MULTI IN	Refer to "Multi In (17 pole and 17+8 pole models)" on page 49		





NOTE

Make sure that the signals are aligned with the pin features and their specific function. In addition, they must be correctly connected to the external device.

Multi Out (17 pole and 17+8 pole models)

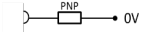
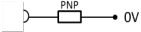
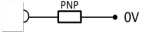
The Multi Out are output signals, configurable depending on the safety application needed. These outputs signals can have the following functions:

TYPE	FUNCTION	DESCRIPTION	CONNECTION
MULTI OUT	MUTING LAMP 1	Active Muting function signal. Connect LED lamp providing it with 24 Vdc	
	MUTING LAMP 2		
	WARNING 1	Outputs for detections in the warning area	
	WARNING 2		
	ALARM 1	Clean window	
	ALARM 2	Device error	
	OSSD 21	Activates the second OSSD pair	
	OSSD 22		
	OVERRIDE STATUS	If it is high level, Override is active	
	NO FUNCTION	not used	

Multi In/Out (17 pole and 17+8 pole models)

The Multi In/Out are signals that can be configured both as inputs and outputs. Laser Sentinel allows the operator to connect from one to three OSSD pairs; it is possible to assign to the same electrical pin input and output signals defined as Multi In or Multi Out.



NOTE

The additional OSSDs are aligned to the main outputs OSSD11 and OSSD12 requirements (OSSD11 and OSSD12 are not configurable). If a Multi Out pin is selected, a second signal linked to it will be automatically configured (EN 61496). This will ensure that the two Multi Out outputs will be used for the same purpose.

TYPE	FUNCTION	DESCRIPTION	CONNECTION
MULTI IN/OUT	OSSD 31	Activates the third OSSD pair	
	OSSD 32		
	MULTI IN	MULTI IN/OUT inputs can be configured as MULTI IN inputs	
	MULTI OUT	MULTI IN/OUT inputs can be configured as MULTI OUT inputs	

LASER SENTINEL: THE SLAVE

To create the Laser Sentinel network, the operator has to connect the Slave devices. These are equipped with rotatable side connectors for the input and output connection and will receive data and power supply from the previous devices which in turn will send it to the others.

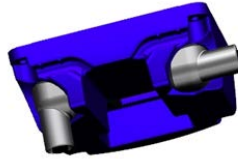

NOTE

It is possible to connect from one to max. three devices at a time.



NOTE

Use 8-pole connectors to connect the Slave devices.

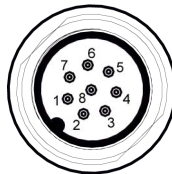

Figure 6 - Connector (M12, 8-pole Male)

PIN OUT	INPUT PORT	OUTPUT PORT
1	V _{PWR}	V _{PWR}
7	V _{PWR}	V _{PWR}
6	I_TX+	O_TX+
5	I_RX+	O_RX+
4	I_TX-	O_TX-
8	I_RX-	O_RX-
2	GND_ISO	GND_ISO
3	GND_ISO	GND_ISO

For the configuration of the Laser Sentinel Master/Slave, the operator must connect the Master to the PC (on which the GUI is installed). Before connecting the Master, make sure that the Slave devices are connected by following the correct order established in advance.



NOTE

All the devices must be switched off during the connection. By supplying power to the Master, all the connected slaves will be switched on automatically.

MASTER SLAVE CONNECTION

- In latest product software versions, Master and Slave devices can be connected through either the right or the left rotating connectors without constraints.
- For older product software versions, please refer to Figure 7. Connection cables are listed in "Ethernet Cables" on page 134 and "Electrical Cables" on page 134.

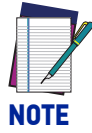

A label on the rotating connector helps the user identify the right connection.



Follow the instructions on the connector labels and do NOT reverse the connections: it may cause malfunctions!

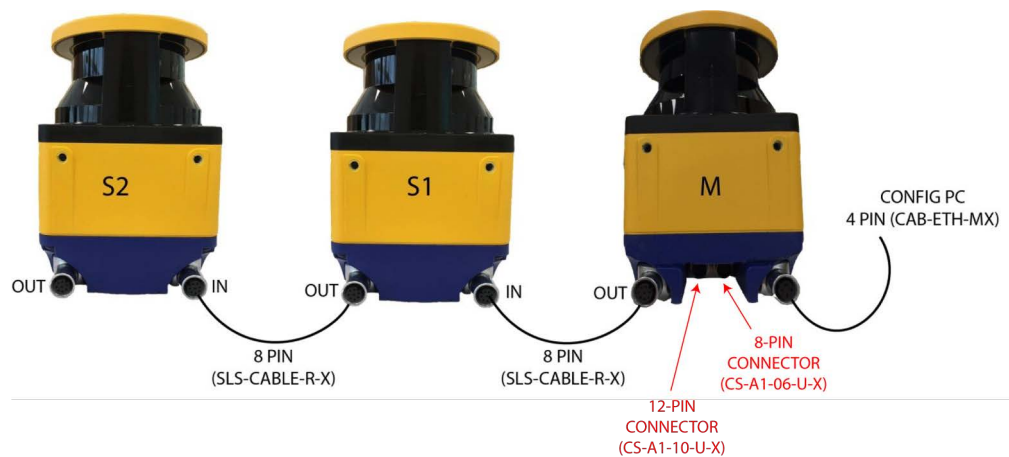
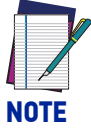

Figure 7 - Master - Slave connection (older software versions)

POWER SUPPLY CONNECTIONS

All power connections to the Laser Sentinel must strictly comply with standard regulations. The device requires a supply voltage of 24 Vdc. Power must be supplied in accordance with SELV/PELV (IEC 60204-1) for all the devices electrically connected to the safety laser scanner. Make sure that the safety laser scanner is provided with an appropriate electrical fuse protection and the earthing system method is the same for all the devices connected to the Laser Sentinel.

**NOTE**

The safety laser scanner's external power supply must be capable of bridging a brief power failure of 20 ms, as per IEC 60204-1.

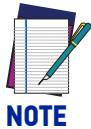
**NOTE**

A functional earth is available on the M12 connector. User can connect or leave floating the functional earth to achieve in the application a best compliance with electromagnetic interferences.

PC CONNECTIONS

Laser Sentinel needs to be connected to the PC for configuration and/or monitoring. The operator must create an Ethernet network between the two devices by employing M12-KEYD connector cable (refer to [Appendix C, Accessories](#) for accessory cables and [Chapter 7, Laser Sentinel Setup and Configuration](#) for Ethernet network setup).

**NOTE**

The device must be powered off during any connection operation. Power up the device after connecting it to the PC for configuration.

**NOTE**

During configuration, the device works using its previously saved configuration. Make sure to follow the safety instructions.

CHAPTER 7

LASER SENTINEL SETUP AND CONFIGURATION

This chapter is dedicated to the Laser Sentinel setup and configuration using the DLSentinel software. The aim of this chapter is to guide the user through all the fundamental procedures of configuring the device.

To employ the safety laser scanner, a safety configuration must be created on DLSentinel, where the user is required to enter all the parameters, configure inputs and outputs and create monitored areas.

For further information about DLSentinel, refer to the DLSentinel User's Manual.

INSTALLING DLSENTINEL GUI

The DLSentinel client application software needs to be installed on your PC to configure the safety laser scanner.

Minimum System Requirements

To ensure proper interfacing with the system, the personal computer must meet the following minimum requirements:

COMPONENT	RECOMMENDED	MINIMUM
Processor(s)	Pentium 4	Pentium 4
Clock frequency	≥ 3 GHz	≥ 2 GHz
RAM	2 GB	1 GB
Free hard drive space	70 MB	70 MB
Monitor resolution	1280x768	1024x768
Supporting Operation System	Windows XP Windows 7 Windows 8 Windows 10	

Besides the components listed in the table above, your PC must be equipped with the following hardware and software drivers:

- Installed Ethernet network card and installed driver
- One free 100 Mbps Ethernet port

Program Installation

DLSentinel is a Datasensing safety laser scanner configuration tool providing important advantages:

- Intuitive Graphical User Interface for rapid configuration
- Defined configuration directly stored in the device
- Discovery and IP address setting features to facilitate remote configuration
- Device Monitoring

To install DLSentinel:

On the PC that will be used for configuration (running Windows XP, 7, 8, or 10), download the DLSentinel.zip file. Extract the file, run the installation program and follow the installation procedure.

When the installation is complete, the DLSentinel entry is created in the Start > All Programs menu under “Datalogic” along with a desktop icon. Double-click the desktop icon to run it.



NOTE

A dedicated computer running DLSentinel must be connected to a Safety Laser Scanner through the Ethernet port to perform the configuration and monitoring features.

CHOOSING THE APPLICATION

The GUI allows selecting the application Type to help the user with the device installation. Depending on which device model is used for the configuration and for the safety monitoring, there are different features and functions.



NOTE

For further information refer to the DLSentinel User's Manual.

CHAPTER 8

FUNCTIONS

ZONE SETTING CONFIGURATION AND SELECTION

A Zone Set defines the set of zones within the Laser Sentinel operating range to be monitored (Safety Zones, and if present, Warning Zone). More than one Zone Set can be configured and these can be switched alternatively using combinations of input signal states.

To create a Zone Set, the user must configure it through the DLSentinel GUI.



NOTE

Each zone set must have a Safety Zone and can have one or two Warning Zones depending on the models.



NOTE

When more than one Zone Set are configured, Safety Area 2 and Safety Area 3 of all Zone Sets coincide and can only be modified from Zone Set 1 (or Zone set 2 if Zone Set 1 is assigned the Shut Off function).

Zone Set Input Selection

When only one Zone Set is configured, it corresponds to the Safety and Warning Zones monitored by the Laser Sentinel and no input signals are needed to manage it.

Laser Sentinel allows the user to set up a given number of Zone Sets: a maximum of six Zone Sets for the Stand Alone model, a maximum of three Zone Sets for the 8-pole Master model, a maximum of ten Zone Sets for the 12-pole Master model, and a maximum of seventy Zone Sets for the 17+8 pole Master model. Only one Zone Set can be activated at a time by using the “Area Switch” configuration inputs. A given combination of inputs is linked to one and only one Zone Set.

When the input signal combination changes, the new Zone Set assigned to this new combination will be monitored.

The Input combination which makes the Zone Sets change (Area Switch) must be univocal and must not be susceptible to false external signals.

It is not possible to switch between two Zone Sets by using only one “Area Switch” input. One electrical wire is not sufficient to create the Area Switching because in the case of a missing signal (i.e. broken wire), an undesired and unsafe Zone Set would result. A system malfunction could also cause the zone to switch, which would not be detected as an error.

To start the Zone Set Switching on the device, the user must:

- Configure at least two Area Switch Inputs.

- Define the input combinations.
- Make sure that the system, which generates the input combination, can dynamically switch the state of the inputs within the required time and without passing through intermediate invalid combination states.

It is possible to insert a delay up to 5010 ms for the input switching (INPUT DELAY) to guarantee the correct timing during the Area Switching. This parameter allows handling the delays caused by the activation and deactivation of Area Switching, which otherwise could put the device in undesired or invalid and temporary switching zone input combinations. As a consequence, this would cause the device to enter the fault state and lock the safety device.

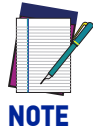

NOTE

The actual zone set switching occurs within a max. processing time of 60 ms after the selected input delay time has expired.

You must wait at least the max. processing time of 60 ms before switching the inputs again. In order to avoid rare but possible lockout conditions due to diagnostics that monitor the correct combination of inputs, make sure that the input signal is not subject to interference or undesirable change of status within this time frame.

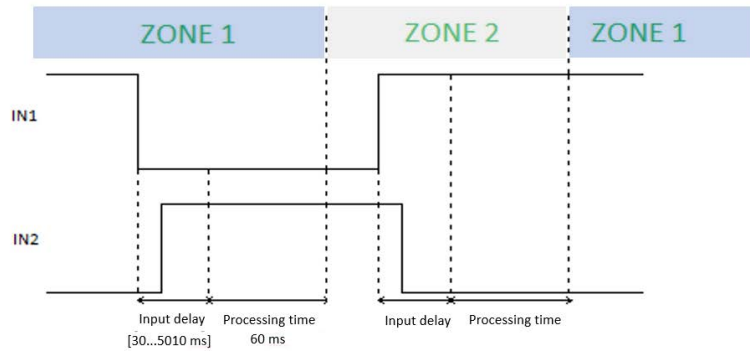

For best performance, it is recommended to update the device to the latest available product software release. For all product software releases prior to 3.1.5, the mentioned processing time should be at least 250 ms instead of 60 ms.

Zone Set Switching

2 Zone Sets

To make the device monitor two different Zone Sets, the user must configure the input combination by selecting the signal “Area Switch”.

1. Enter 2 in “Zone Set no.” (Zone Sets Configuration step).
2. Choose the needed number of active inputs to create univocal combinations.

As an alternative, after entering the Zone Set number, press the coding icon  to automatically fill the area switches.

Zone Set 1

Area Switch 1 = 1, Area Switch 2 = 0;

Zone Set 2

Area Switch 1 = 0, Area Switch 2 = 1;

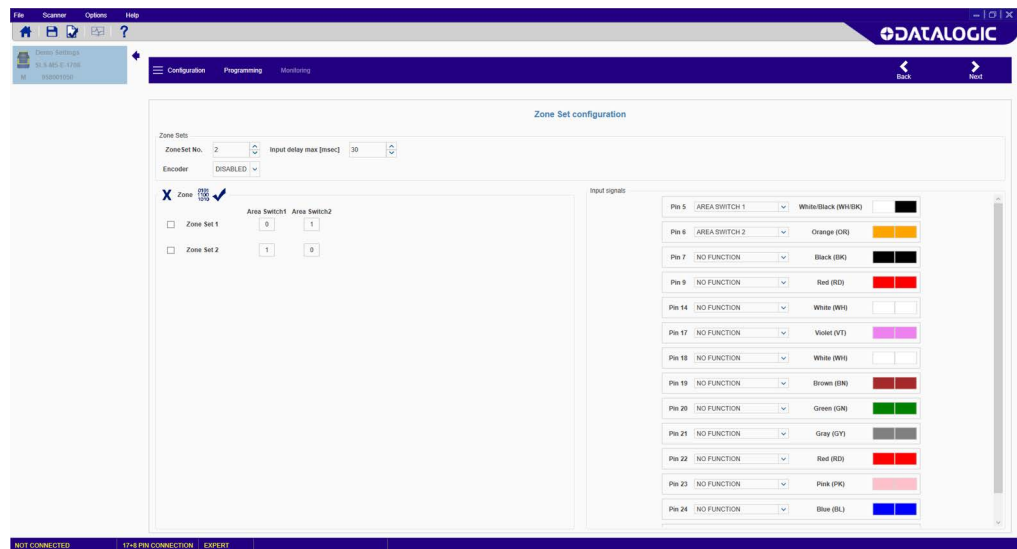

Figure 1 - 2 Zone Sets

As mentioned before, the Stand Alone and the Master models differ in the maximum number of configurable Zone Sets. The Stand Alone model provides for up to six Zone Sets and three inputs to be set as Area Switch; with the M12 12-pole Master model you can have up to ten Zone Sets and five inputs for Area Switching. For more details, see the sections below.

Stand Alone model: 6 Zone Sets

In order to make the device monitor six different areas, the user must configure the Zone Sets page to define and assign input signal combinations to “Area Switch” inputs and check that the switching equipment that generates the sequence does not violate any combination states according to the Switching State Map shown below.

The following diagram shows the valid Zone Set state switching. Any sequence not connected by an arrow is not valid. For example, a Zone Set assigned 011 cannot switch to a Zone Set assigned 001. This would violate the requirement that at least two Area Switch inputs change signal levels from one zone to the next. Any such implementation will cause the Laser Sentinel to go into fault state (lockout).

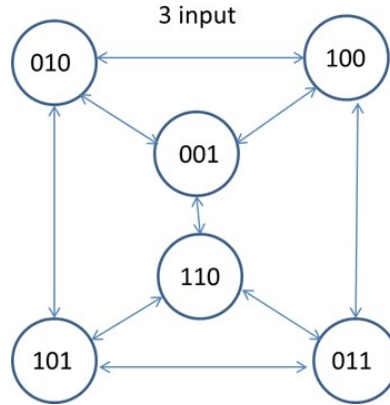



Figure 2 - Switching State Map

1. Set the Zone Set No. to “6”. Six Zone Sets will appear with their relative Area Switch combinations.
2. Assign a univocal combination to the Area Switches. The easiest way is to use the binary coding icon  to automatically set the input combinations. Example:

Zone Set 1:	Area Switch 1 = 0	Area Switch 2 = 1	Area Switch 3 = 0
Zone Set 2:	Area Switch 1 = 1	Area Switch 2 = 0	Area Switch 3 = 0
Zone Set 3:	Area Switch 1 = 0	Area Switch 2 = 1	Area Switch 3 = 1
Zone Set 4:	Area Switch 1 = 1	Area Switch 2 = 0	Area Switch 3 = 1
Zone Set 5:	Area Switch 1 = 1	Area Switch 2 = 1	Area Switch 3 = 0
Zone Set 6:	Area Switch 1 = 0	Area Switch 2 = 0	Area Switch 3 = 0



NOTE

The combinations 000 and 111 are not allowed.

3. Assign each Area Switch to an available Input Signal Pin.



NOTE

The Stand Alone Laser Sentinel has three configurable Inputs. If the user chooses to employ from three to six Zone Sets there will be no available I/O for other functions. For example, it will not be possible to employ the Manual Restart or send an electrical warning signal.

The following figure shows the possible input combinations in case of six Zone Sets.

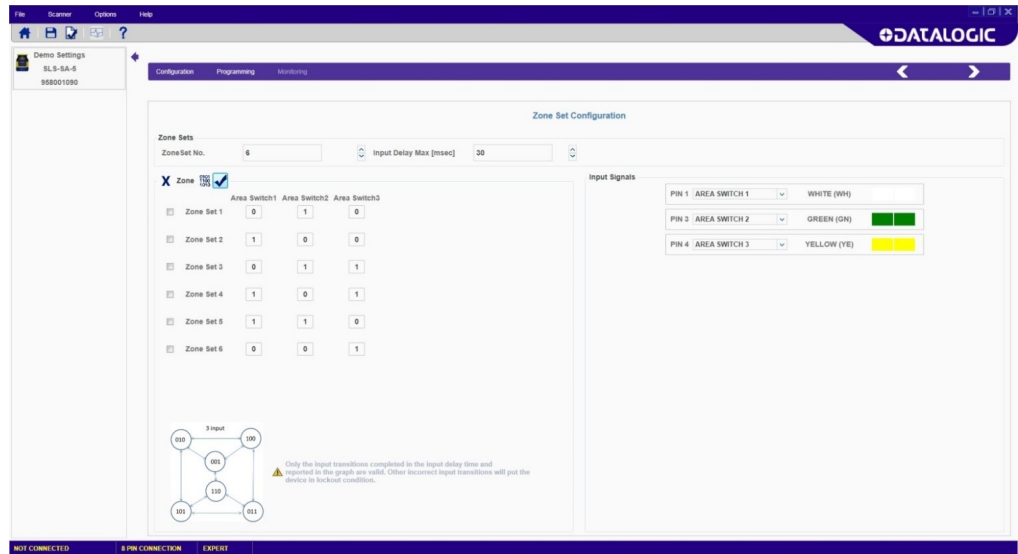

Figure 3 - Six Zone Sets (Stand Alone model)

M12 12-pole Master model: 10 Zone Sets

The M12 12-pole Master model can monitor up to 10 different areas. To do that, the user must configure the input combination by selecting the signal “Area Switch”, set five inputs as Area Switch and then create a sequence of univocal combinations as described above.

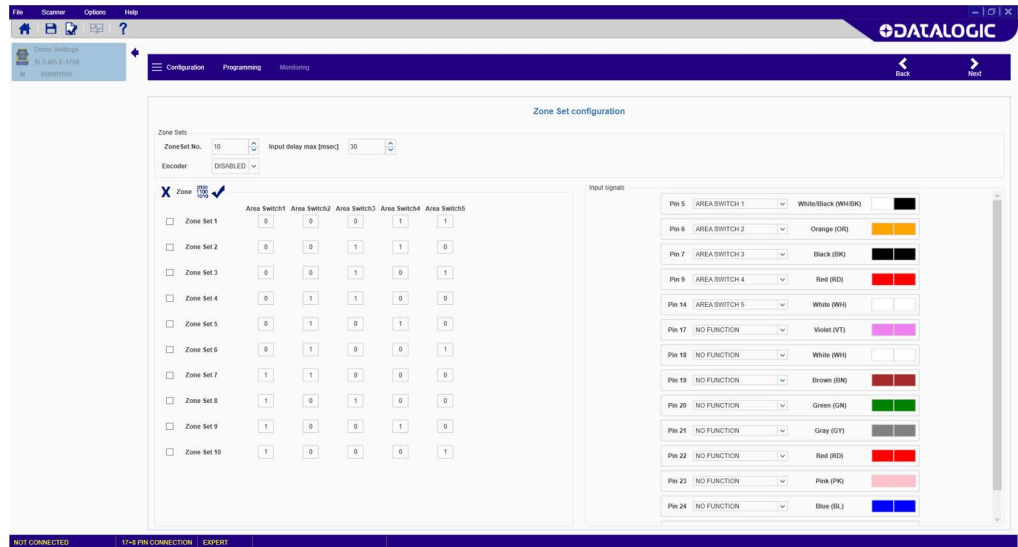

Figure 4 - 10 Zone Sets (Master model)



NOTE

The 8-pole Master model provides for up to three Zone Sets and three configurable inputs.

M12 17+8 pole Master model: 70 Zone Sets

The M12 17+8 pole Master model can monitor up to 70 different areas. To do that:

1. Set the Zone Set No. to "70". 70 Zone Sets will appear with their relative Area Switch combinations.
2. Assign a univocal combination to the Area Switches. The easiest way is to use the

binary coding icon  to automatically set the input combinations.

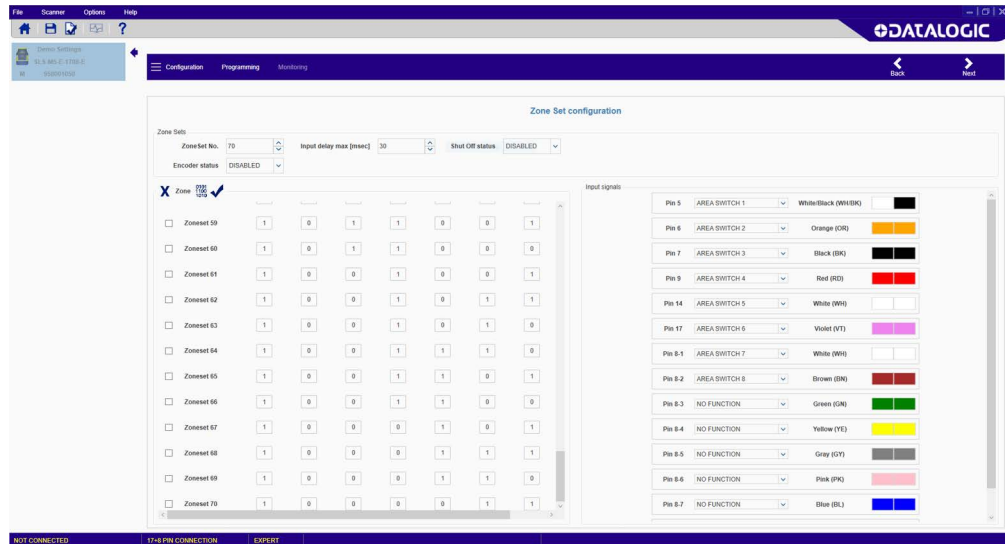

Figure 5 - 70 Zone Sets (Master model)



The combinations 000 and 111 are not allowed.

NOTE

3. Assign each of the eight Area Switches to an available Input Signal Pin.

DETECTION CAPABILITY SETTING

The detection capability is the ability to detect an object of given dimensions within the detection zone. In particular, for the Laser Sentinel, the test piece taken as reference is an opaque cylinder with at least 300mm height and the diameter equal to the detection capability measured in millimeters.

The safety laser scanner, configured with a given detection capability, will be able to detect objects within the Safety zone; the device is also capable of detecting objects located in the Warning zone, but the probability of detection errors could be greater than the one guaranteed for the Safety Zone (due to specific object color or reflecting surface).

The detection capability is a parameter that the user selects through the GUI. The user selects the detection capability depending on the application requirements, because it is a critical parameter in the calculation of the minimum safety distance from the hazard point.

The detection capability also influences the maximum detection range of the scanner.

MODELS	DETECTION CAPABILITY	MAX. RANGE
Master/Slave & Stand Alone 5.5 m	30 mm	2.5 m
	40 mm	3 m
	50 mm	4 m
	70 mm	5.5 m
	150 mm	
Master/Slave & Stand Alone 3 m	30 mm	2.5 m
	40 mm	3 m
	50 mm	
	70 mm	
	150 mm	

AUTOMATIC AND MANUAL RESTART

If Laser Sentinel detects an opaque object, the OSSD outputs switch to the OFF-status (the opening of the safety contacts). The restart mode allows the safety laser scanner to return to a normal operating condition.

The restart of the device (the closing of the OSSD safety contacts) can be carried out in two different ways: Automatic or Manual Restart.

Automatic Restart

When an opaque object is detected, the safety laser scanner enters the safe condition. After the object has been removed from the safety area, the device normal functioning is restored.

The response time is the time between the object introduction in the Safety area and the OSSDs achieving the STOP condition. The recovery time is the time between the object removal from the protected area and the OSSDs achieving the GO condition.

The Automatic Restart can be set through the GUI and the minimum recovery time for device restart is 200 ms. This time can be increased up to 60000 ms through the GUI.



NOTE

OSSD 1/1 1/2 has both Automatic and Manual Restart functions.

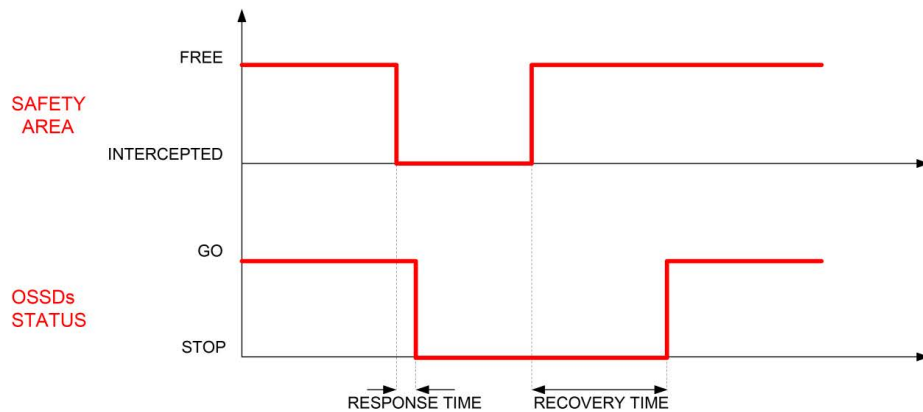

Figure 6 - Restart timing (auto)

Manual Restart

After the safety laser scanner has detected an opaque object in the Safety area, normal operation will be restored only by pressing the Restart button (normally open push-button) after the object has been removed from the Safety zone.

The Restart push-button must be kept pressed between a minimum of 500 ms and a maximum of 4.5 seconds. When the Restart push-button is released, the OSSD outputs switch to normal operation.

There are two intermediate states (internally controlled) between the stop and the restart of the safety laser scanner: the Interlock ON (device normal operation can be restored, because the detected object has been removed from the Safety zone) and the Interlock OFF (the device is OFF because the object has not been removed from the Safety zone).



NOTE

The Interlock ON will be signaled by a LED located under the device display (refer to "LEDs and Display" on page 102).

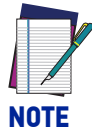

The Manual Restart input must be connected to a 24 Vdc normally open contact.

NOTE

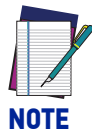

If an object is not removed from the Safety zone and the operator attempts to restart the device, by pressing the button for more than 500 ms, the Safety Laser Scanner remains in Interlock OFF status.

NOTE

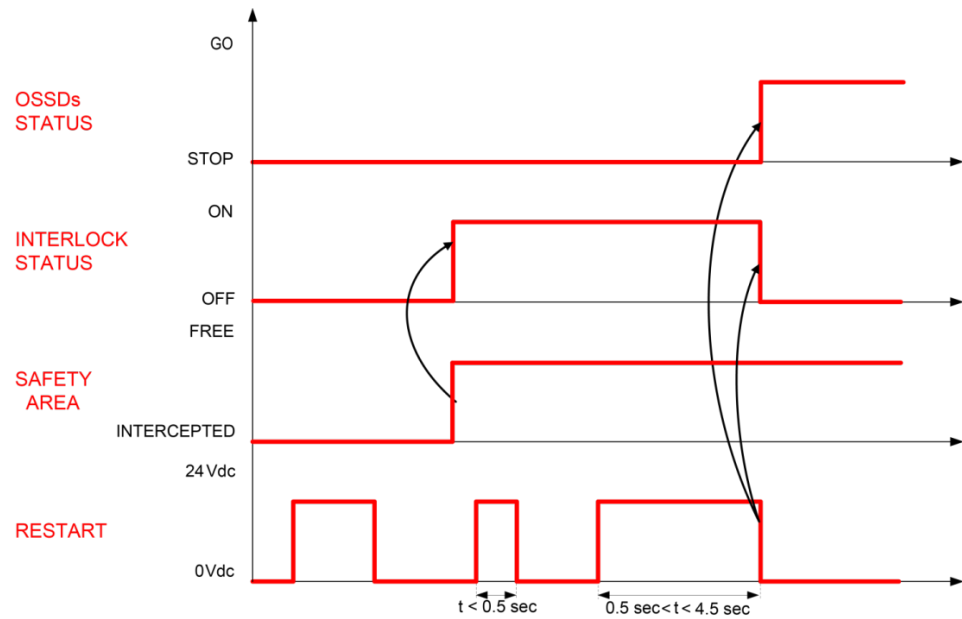

Figure 7 - Restart timing (manual)

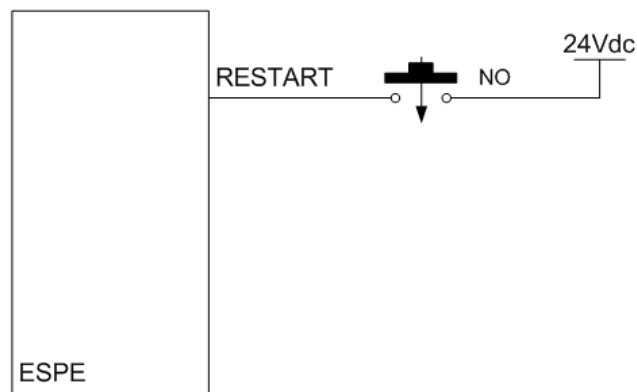

Figure 8 - Restart connection (manual)

RESPONSE TIME AND SCAN CYCLE SETTING

The response time of the Laser Sentinel is the time from when an object enters the safety zone to when the OSSD goes to the OFF-status due to the detection of the object. The Laser Sentinel scans cyclically the surrounding area at constant speed. The time for an entire cycle is so fixed and called "scan cycle time". It depends on the selected code for anti-interference as per table below.



NOTE

The response time of the Master Slave system corresponds to the response time of the logical safety output of the device that goes into STOP and the network latency time. If the Master device is in STOP, no latency should be added. If the Slaves are in STOP, then the latency time must be added to the response time of the single device.



NOTE

The minimum response time of the safety laser scanner is 62 ms, which is the time needed by the device to perform two scans, with anti-interference code = 0.

The number of scans of the response time may be increased if the device is operating in a dirty environment caused by floating dust particles (in this case, the user may need to set a higher number of scans before turning off the OSSDs in order to avoid false detections).



NOTE

The response time is automatically calculated by DLSentinel based on the number of connected devices, scan cycles, and the selected anti-interference code (see "Anti-Interference Coding" on page 88).

The response time automatically calculated by DLSentinel is approximated up to the highest integer value in milliseconds.

The scan cycle time is:

30 ms for selected anti-interference code 0

30.5 ms for selected anti-interference code 1

31 ms for selected anti-interference code 2

31.5 ms for selected anti-interference code 3

The number of scan cycles reaches max. 40 (on Enhanced Laser Sentinel devices).

In case of Master/Slave configuration, a network latency time of 10 ms must be added for each Slave device connected on the network.

The response time varies from min. 62 ms (no Slave devices connected, anti-interference code = 0, no. of scan cycles = min. 2), to max. 1292 ms (1 Master + 3 Slave devices, all with anti-interference code = 3, no. of scan cycles = max. 40).

The formula to calculate the response time is as follows:

$$\text{Response time} = (\text{scan cycle time} * \text{no. of scans}) + 2\text{ms} + (\text{network latency time} * \text{no. of connected Slave devices})$$

The following table gives an example of response times with all devices using anti-interference code = 0:

Master Stand Alone OR Stand Alone model	62 (...1202) ms
1 Master + 1 Slave device	62 (...1202) ms + 10 ms = 72 (...1212) ms
1 Master + 2 Slave devices	62 (...1202) ms + 20 ms = 82 (...1222) ms
1 Master + 3 Slave devices	62 (...1202) ms + 30 ms = 92 (...1232) ms

**WARNING**

If the safety distance is not appropriate for the application, the machine may not stop before the dangerous area is reached.

**NOTE**

If the application requires changes, this may require reconfiguration of the safety zones or re-installation of the Laser Sentinel.

REFERENCE POINTS MONITORING SETTINGS

Reference points monitoring is a safety function used to monitor any change in position of the scanner, a protective structure or a moving structure located at the specified reference points. These structures either allow or prevent access to the dangerous area and are therefore outside the monitored Safety Zone.

When the device detects a change in position at the Reference Points exceeding the specified tolerance, the OSSD goes to the OFF-state. This function is required for Vertical applications.

Example application for movable structure protection

When the reference points (minimum 3), are set on the position of a movable structure, such as a door, the OSSD goes to the OFF-state if the Laser Sentinel detects a change in the position of the door.

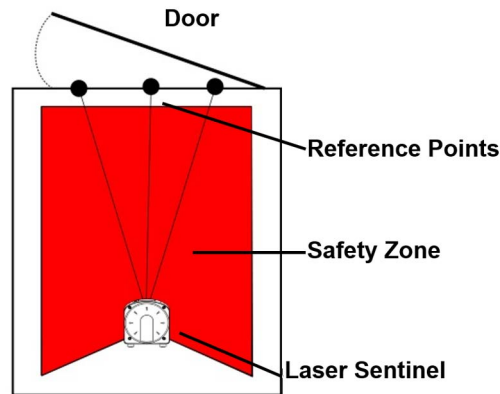

Example application for protective structure protection

When protective structures such as mechanical guards or barriers are used in combination with the safety laser scanner, undetected access to the dangerous area could be compromised if some event occurs which moves the position of the protective structure. To avoid this, Reference Points can be set on the protective structures to monitor their position. The OSSD goes to the OFF-state in case of a position change of the protective structure.

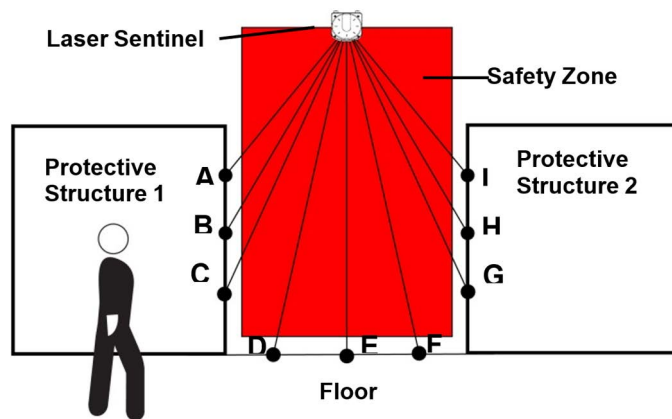

Example of reference points

As shown in the figure above, three or more reference points must be set on each structure to detect its position change. Three reference points are set on three structures (protective structure 1, protective structure 2 and the floor) for a total of nine points (A to I).

Additional measures must be provided if there exists any unprotected space larger than the minimum detectable object size between the Safety Zone and the protective structure.

- At least 3 Reference Points must be defined per object. A maximum of 15 Reference Points total can be defined.
- The Reference Point tolerance must be set for each Reference Point through the GUI. The minimum tolerance is +/- 10 mm where Tol - is the tolerance closest to the scanner and Tol + is farthest from the scanner measured on a radial line from the scanner origin.
- If the user configures a vertical application with a number of Scans greater than 2, the GUI gives a warning message indicating that this configuration is not valid for whole body protection applications (greater than 1.6 m/s). To safely apply the Laser Sentinel in applications with normal approach (i.e. when the monitored plane is vertical), refer to IEC 61496-3 Annex A.12.

**NOTE**

If the Muting function is enabled, the Reference Points must be configured in such a way that they are not detected by the moving material during Muting. Otherwise, the Safety Laser Scanner will go to “OFF state for Reference Point” and the OSSDs will switch to OFF state to stop the machine.

SAFETY OUTPUTS (OSSDs)

The OSSD (Output Signal Switching Device) is a safety output for safety-related parts of a machine control system. When the device detects an object or a person in the Safety zone, the OSSD goes to the OFF-status (the machine stops). The device generates signals to monitor the OSSD status and these periodically force the OSSD into a temporary OFF condition if the OSSD is ON (when there is no object detected in the Safety zone). If the OFF signal does not return to the internal control circuit, the Safety Laser Scanner will switch into fault status. An OSSD pair must always be wired to a safety-related part of a machine control system to ensure safety.



WARNING

To avoid dangerous conditions, the user must never wire only one OSSD to a safety-related part of a machine control system.



WARNING

The safety contacts of each OSSD couple cannot be connected in series or in parallel, but they must be used separately (in the double channel safety controller input). An erroneous configuration will cause the device to switch the output into failure condition. Connect both OSSDs to the device to control: otherwise the degree of system safety that the Safety Laser Scanner has to control will be put in danger.

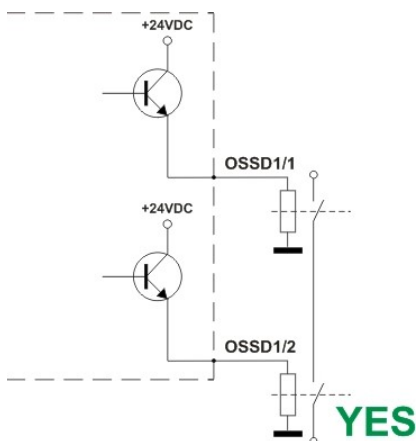

Figure 9 - Correct connection of the load

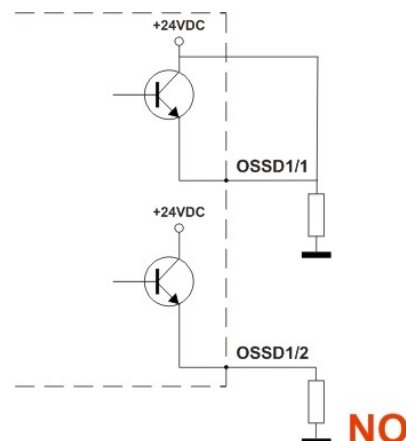

Figure 10 - Incorrect connection of the load (1)

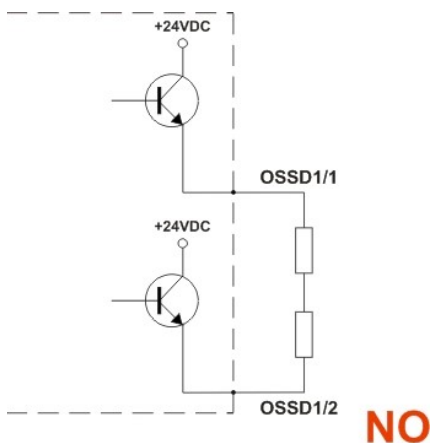

Figure 11 - Incorrect connection of the load (2)

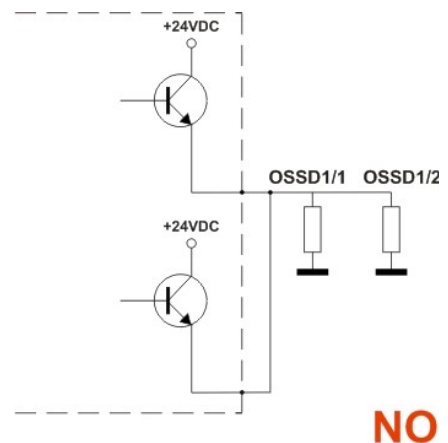
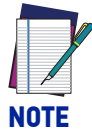

Figure 12 - Incorrect connection of the load (3)

**NOTE**

OSSD 1/1 must be paired with OSSD 1/2.

OSSD 2/1 must be paired with OSSD 2/2.

OSSD 3/1 must be paired with OSSD 3/2.

OSSD test

The following diagram illustrates the different times needed for OSSD tests.

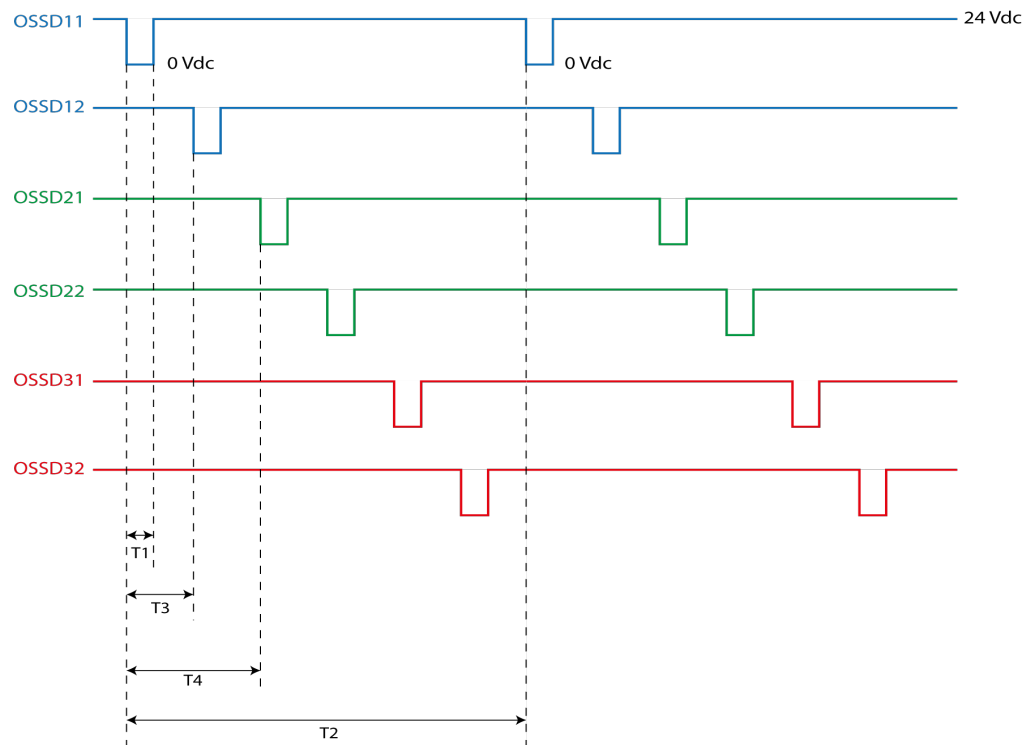

Figure 13 - OSSD test

Where:

T1 (Test pulse width) = 115 μ s

T2 (Test period on single OSSDx) = 900 ms

T3 (Shift time between OSSD pairs) = 150 ms

T4 (Shift time between OSSDs) = 300 ms

MUTING

The Muting feature allows the automatic deactivation of the safety status on the whole (Total Muting) or part (Partial Muting) of the safety area. This feature is particularly suitable when an object, but not a person, has to pass through the dangerous area. This allows carrying out definite cyclical operations without blocking a working machine.

The Muting feature excludes the ESPE during its functioning, but it maintains the OSSD outputs active (according to particular operating requirements). To activate the Muting feature, the safety laser scanner is equipped with two inputs, Muting 1 and Muting 2 (according to the current Standards).

The Muting sensors must be placed according to the material's length and speed to be able to recognize the passing materials (pallets, vehicles, etc.). If a muting area has different speeds, it is necessary to evaluate their effect on the total muting duration.

It is important to remember that the Muting feature represents a forced condition of the system and therefore has to be used with the necessary precautions.

If Muting 1 and Muting 2 inputs are activated by two Muting sensors or actuators, these should be correctly connected and placed to avoid undesired Muting or potentially dangerous conditions for the operator.



NOTE

Muting 1 and Muting 2 cannot be activated simultaneously. Muting status is signaled by an external Muting Lamp that may be connected to the safety laser scanner and the display of the user interface. When the Muting function is ON, the lamp blinks and the display shows "MUTING". The lamp must be always placed in a visible location.



NOTE

The Muting zone can be different for each Zone Set configured on each device. Please note that when you enable Muting, you disable the safety function on the relevant safety zone (which may be shared between multiple Master or Slave devices) and for all Zone Sets.



NOTE

Up to two Muting zones can be configured in a Safety Area.



WARNING

Carefully select the configuration, because a wrong one can cause the incorrect functioning of the Muting feature and a reduction of the safety level. To correctly use the Muting feature, please refer to the relevant reference standard.



WARNING

The Muting sensors must be placed so that during the activation of the Muting feature it is not possible for a person to pass through the desired zone.



NOTE

Check that when the Muting function is active no Zone Set switching occurs. Zone switching is not allowed during Muting, and if this occurs, the system will display an error (INPUTCF2) as soon as the Muting function ends.

Muting Enable

When the Muting feature is implemented (through two Muting inputs), a third input can be used to dynamically control whether Muting will be performed or not. The third input is labeled MUTING ENABLE and works as follows:

prior to a valid Muting sequence on the Muting inputs, if the MUTING ENABLE signal is at a high level, the Muting feature is enabled, and Muting will be performed; if the MUTING ENABLE signal is at a low level, the Muting feature will not be performed.

Muting Signaling Devices

Muting status is signaled by an external Muting lamp that may be connected to the safety laser scanner. The lamp blinks when the Muting function is active.



NOTE

The Muting Lamp must only be a LED lamp type, max consumption 250 mA.

Muting Direction

It is possible to use the ESPE both in a bi-directional and unidirectional Muting. In particular, the bi-directional Muting is used if the materials move in both directions and the unidirectional Muting is used if the materials move in one direction only.

Bidirectional Muting

In Bidirectional type operations, the device enters in Muting if the Muting 2 input goes high after the rising of Muting 1 (or vice versa), within the Max Muting Inputs Delay ($T_{12\ max}$ or $T_{21\ max}$ in the figure below). It is possible to set the Max Muting Inputs Delay between Muting 1 and Muting 2 (or vice versa) from a minimum of 1 sec to a maximum of 16 sec.

As soon as the signal on Muting 1 or Muting 2 goes low, the Muting function ends, after an internal delay of max 30 ms (T_{delay}).

The Timeout parameter forces the Muting feature to end if the MUTING inputs remain in the active state.

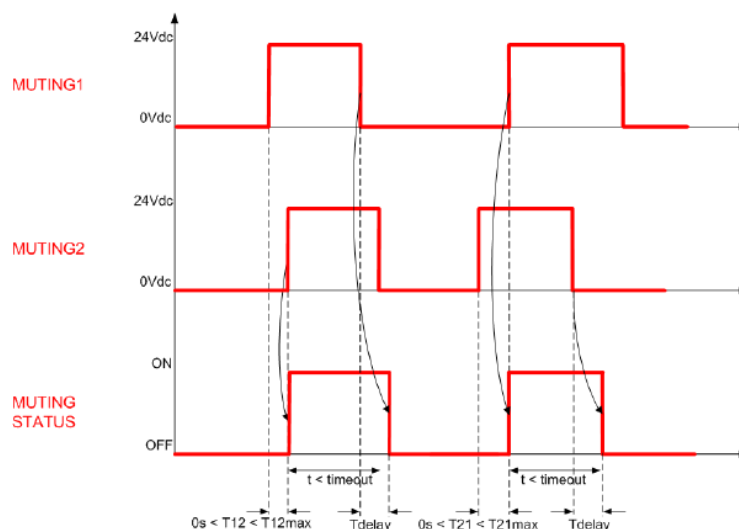
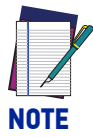

Figure 14 - Bidirectional Muting Timings

The sensors A1/A2 are connected to Muting 1 input and the sensors B1/B2 are connected to Muting 2 input. The user has to mount the sensors A1/A2 or B1/B2 at a “D” distance.



NOTE

“D” depends on the package length (L): $D < L$; “d1” is the maximum distance between the Muting sensors (this distance depends on the package speed (V): $d1_{max}[cm] = V[m/s] * T12[s] * 100$); “d2” is the maximum distance for the Muting request to be accepted (this distance depends on the package speed (V): $d2_{max}[cm] = V[m/s] * T12[s] * 100$, where “T12” is the delay between Muting 1 and Muting 2. The user should select the minimum value of T12 max (DLSentinel, parameter Max Muting Inputs Delay) that guarantees the Muting function.

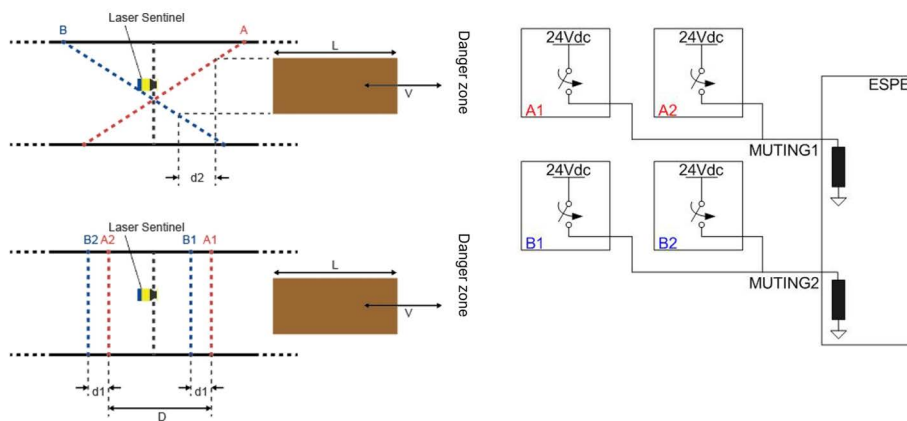

Unidirectional Muting

In Unidirectional type operation, the device enters in Muting if the Muting 2 input goes high after the rising of Muting 1 (or vice versa). The user can set the value of Max Muting Inputs Delay between Muting 1 and Muting 2 from a minimum of 1 sec to a maximum of 16 sec.

The Muting function goes OFF after a specific time: it is a multiple of the real delay between Muting 1 and Muting 2 (T12). The user can choose the value of the multiplier "m" (M coeff. in DLSentinel).

After this interval, to re-enter in a Muting operation, the Muting input has to be deactivated and the sequence needs to start from the beginning.



NOTE

Unidirectional Muting must be used only for removing materials from the dangerous area.

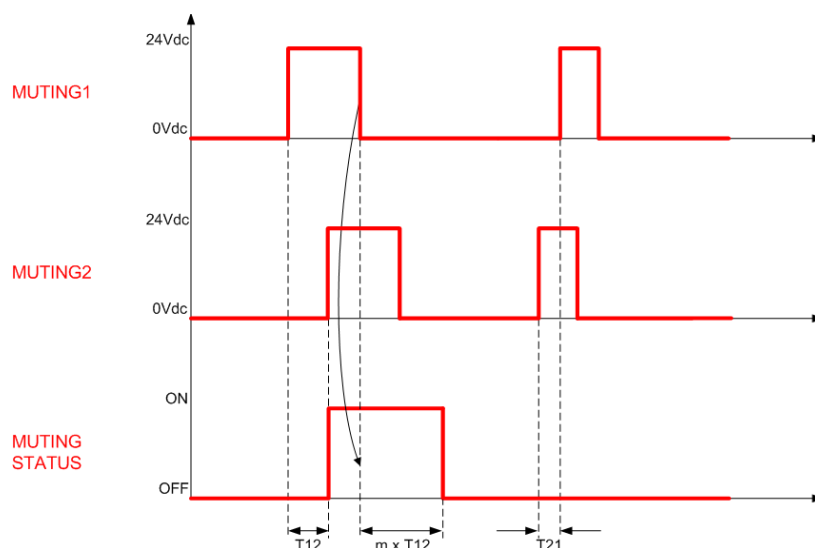

The figure below shows this operation: the pack moves from the right to the left only. "V" indicates a constant speed; therefore, "d1" is a fixed value according to the following formula:

$$d1[\text{cm}] = V[\text{m/s}] * T12[\text{s}] * 100$$

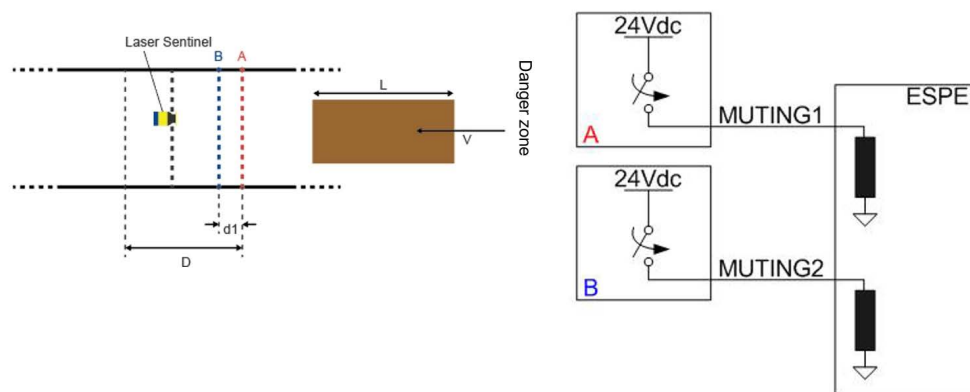

Configuring the Muting Function on DLSentinel

To enable the Muting function on DLSentinel and configure the Muting area, follow the procedure below:

1. On the Output Configuration page, set the Muting item to ENABLED.

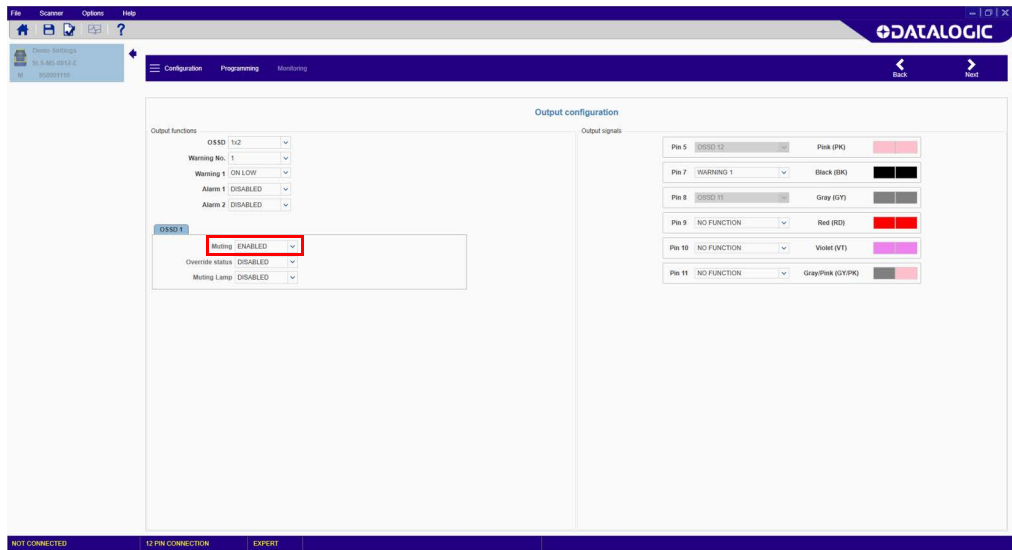

2. On the Input Configuration page, assign the Muting signals to the available pins.

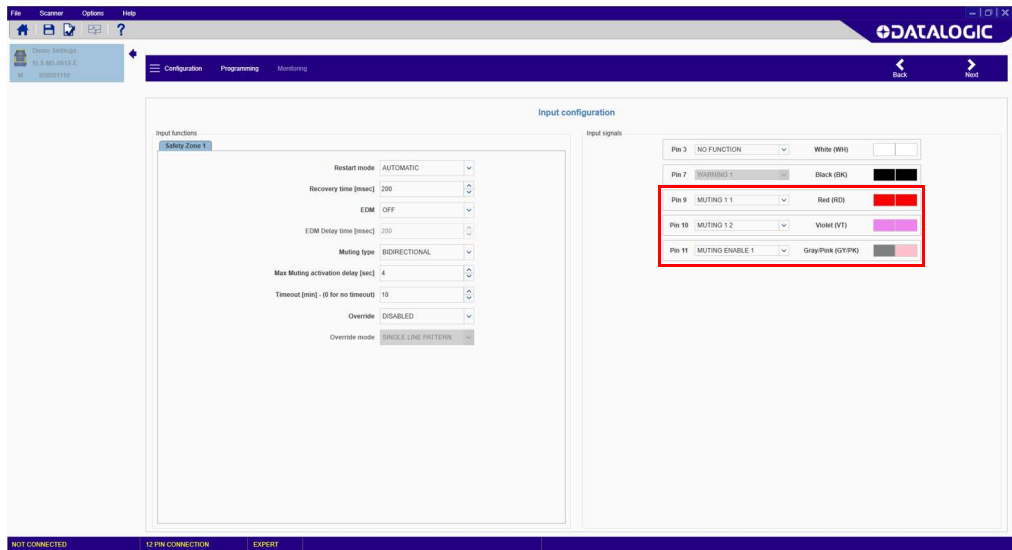

- On the Zones Configuration page, first draw your Safety Area, then click on the Muting 1 label in the panel on the left side. A warning message is displayed informing the user that any change to the Safety Area will remove the Muting zone. Click OK to proceed.

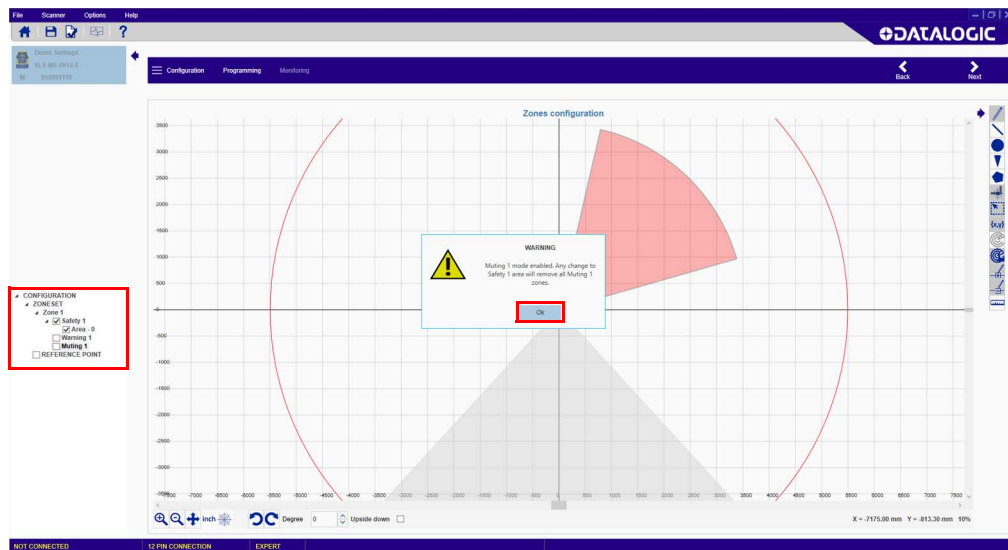

- An additional warning message is displayed. To create a Total Muting zone corresponding to the whole Safety Area, click YES.

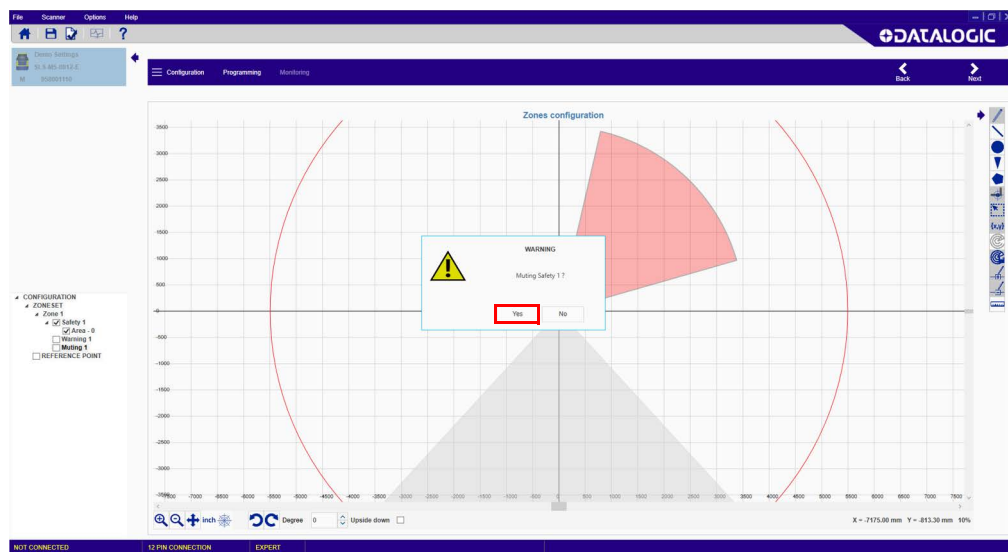

- If a Total Muting zone was created, the Muting zone (colored blue) will overlap the Safety Area, as illustrated in the picture below.

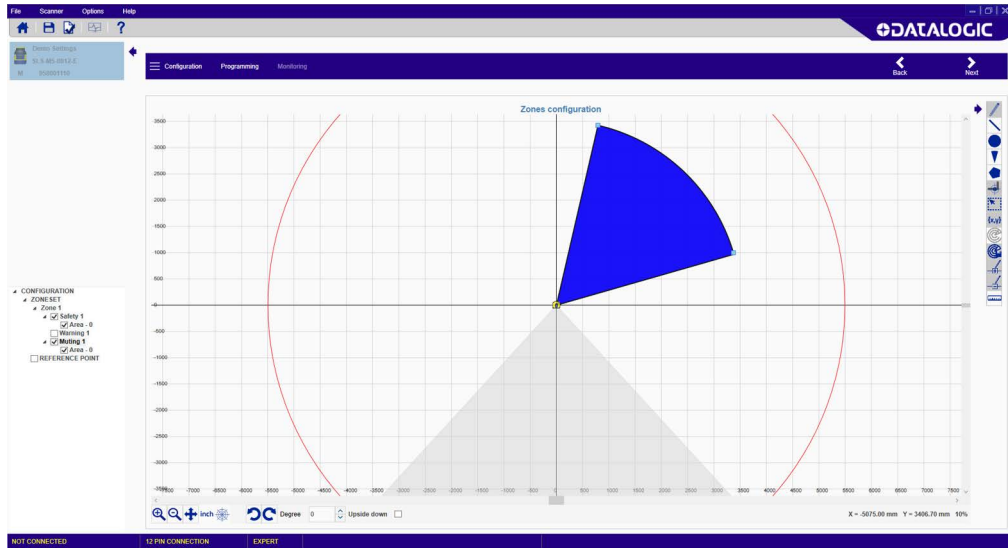

A Total Muting zone can be turned into a Partial Muting zone by dragging and dropping the points of the shape. In this case, the Muting zone will have the same radius as the Safety Area.

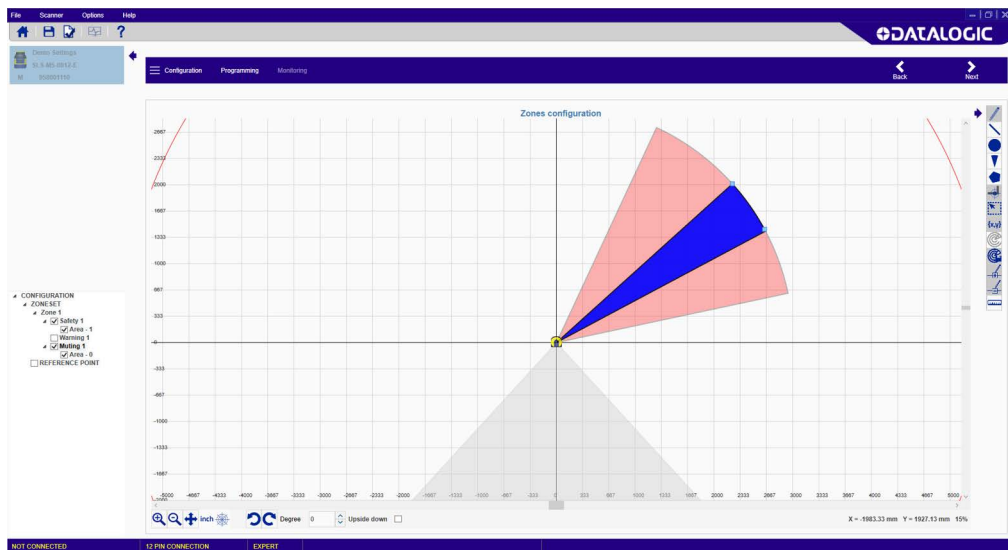

If the desired Partial Muting zone has a smaller radius than the Safety Area, click NO on the last warning message. Then select the desired shape and draw your Muting zone starting from the outer edge of the Safety Area.

OVERRIDE

Muting Dependent Override in Stand Alone Model

The Override feature is possible when the Laser Sentinel is in the SAFE state (detection in the Safety Zone) and allows the user to force the OSSDs to ON state whenever it is necessary to restart the machine. The aim is clearing the protected area of any working materials blocked ahead of the device, because this interference may cause a work cycle anomaly.

According to the safety requirements, the device is equipped with one override activation input: OVERRIDE 1.

In order to be accepted, an override request must have: the safety laser scanner in SAFE status and at least one Muting sensor intercepted. If this condition is true, the display will show the OVERRIDE warning and the OSSD LED will be ON green.

The override function can be activated as follows:

Single input line pattern

The input sequence to be followed for activation is indicated in the figure below:

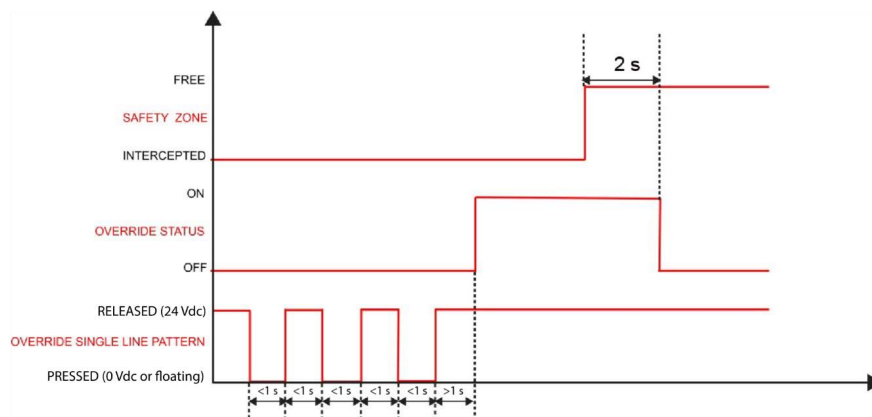

If the sequence is not respected, the override function does not activate.

Muting Dependent Override in Master Model

The Override function applies to the Master model and extends to the Master/Slave system if Slave devices are connected. The GUI makes it possible to enable the override function only if the Muting function is active.

In order to be accepted, an override request must have: the safety laser scanner in SAFE status and at least one Muting sensor intercepted. If this condition is true, the display will show the OVERRIDE warning and the OSSD LED will be ON green.

The safety logic will have priority: even if the override is active, the OSSDs will still go to STOP if the safety areas detect devices that do not have the override function selected. The possibility of selection gives the system more flexibility, but it is obviously subject to a risk analysis by the user.

The Override function will automatically end when one of the following conditions is verified:

- all the muting sensors are deactivated (in a Bidirectional Muting configuration)
- all the muting sensors are deactivated, and no beams are intercepted (in a Unidirectional Muting configuration)
- after the 120 second fixed timeout

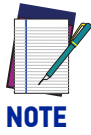

NOTE

Check that when the Muting function is active no Zone Set switching occurs. Zone switching is not allowed during Muting, and if this occurs, the system will display an error (INPUTCF2) as soon as the Muting function ends.

Single input line pattern

The input sequence to be followed for activation is indicated in the figure below:

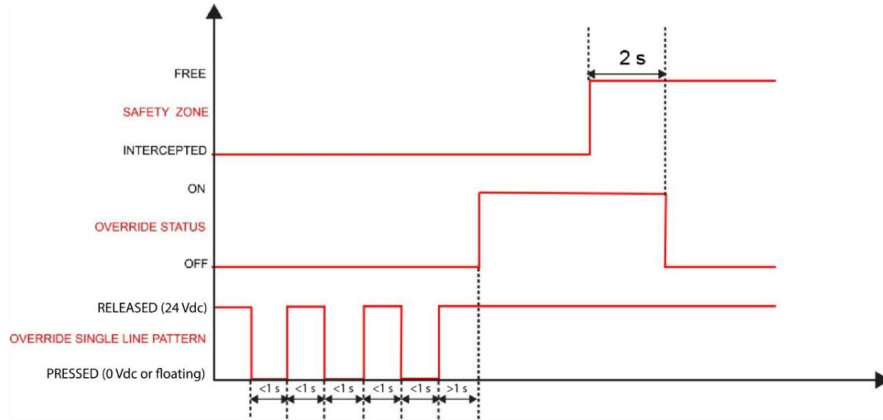

Level triggered pattern

The input sequence to be followed for activation is indicated in the figure below:

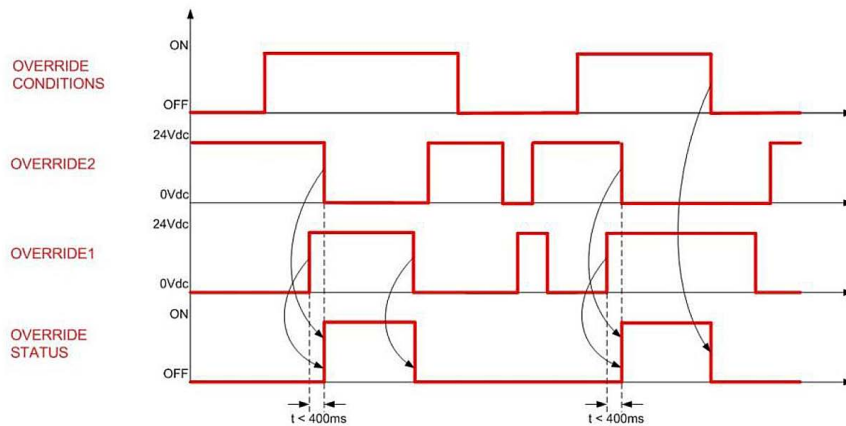

Edge triggered pattern

The input sequence to be followed for activation is indicated in the figure below:

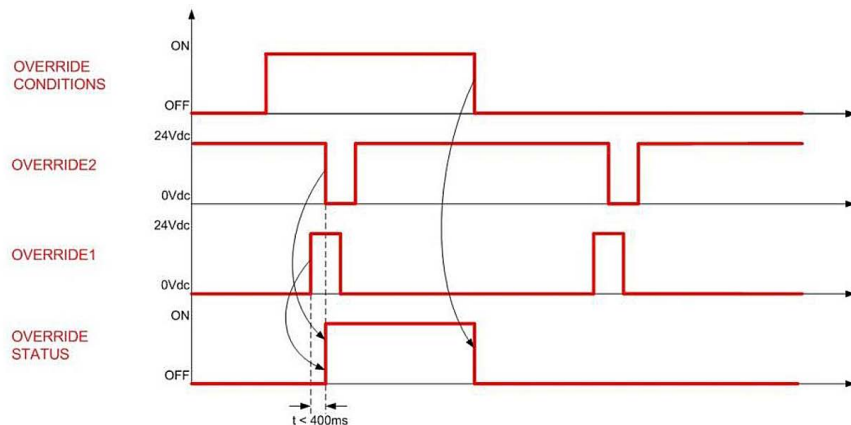

**NOTE**

The Level and the Edge triggered patterns can be enabled with the M12 12 or 17-pole Master connector only.

**NOTE**

Please note that when you enable Override, you disable the safety function on the relevant safety zone (which may be shared between multiple Master or Slave devices) and for all Zone Sets.

EDM

The External Device Monitoring (EDM) function controls external devices by verifying the OSSDs status.

EDM enabled

When EDM is enabled it is necessary to connect the EDM input to a 24 VDC normally-closed contact of the device to be monitored.

The figures below show how to connect the EDM input.

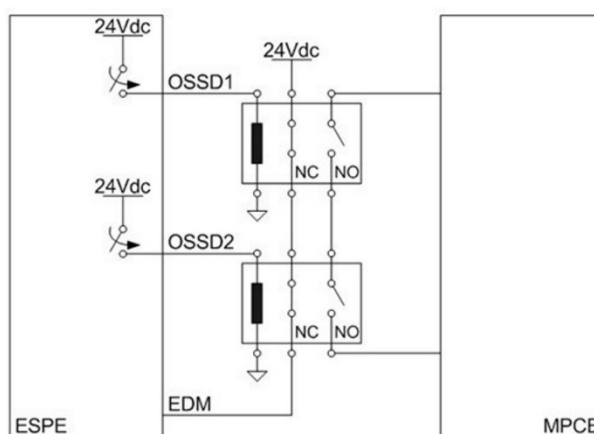

Figure 15 - EDM connection with automatic restart

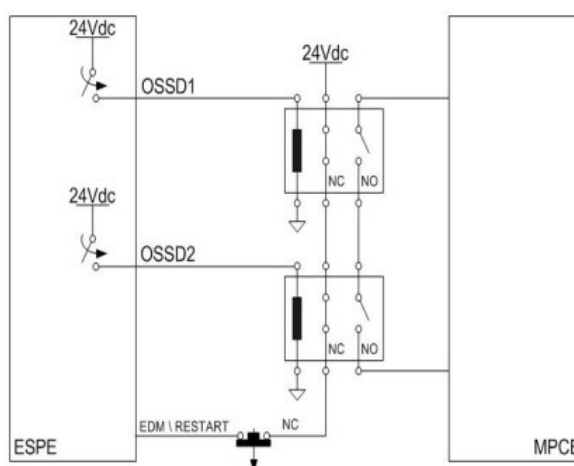

Figure 16 - EDM connection with manual restart

The function controls the 24VDC normally-closed contact switching according to the changes of the OSSDs status.

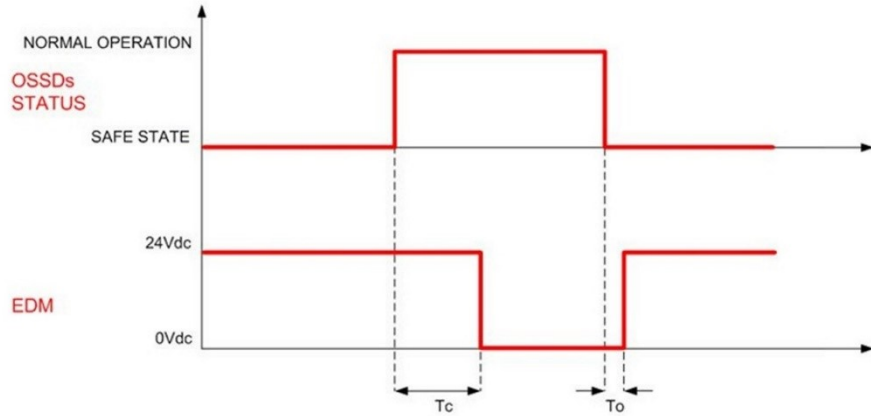

Figure 17 - EDM timings

The EDM status is antivalent with OSSDs: the timing diagram explains the relationship between the cause (OSSDs) and the effect (EDM) with the maximum permissible delay. DLSentinel makes it possible to adjust the maximum permissible delay between 200 and 1000 ms.

- $T_c \leq 350$ ms (time between OSSD OFF-ON transition and EDM test)
- $T_o \geq 100$ ms (time between OSSD ON-OFF transition and EDM test)
- (two different times for the mechanical contact driven by a spring)

EDM disabled

When EDM is disabled it is necessary to leave the EDM input floating.

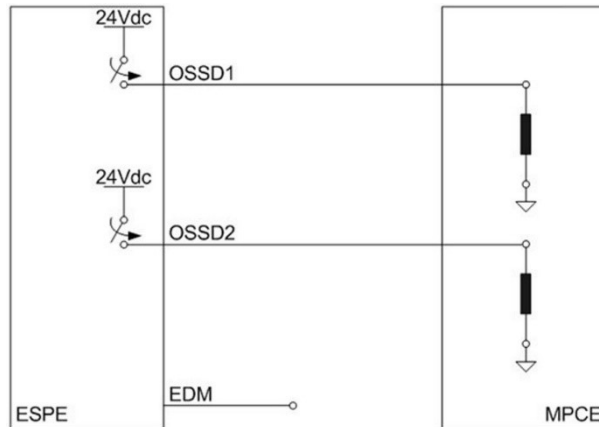

Figure 18 - EDM disabled

ENCODERS

In dynamic applications, the safety area can change according to the position, direction, and speed of the vehicle. A typical example is the use of the Safety Laser Scanner on an Automated Guided Vehicle (AGV). If the speed changes, the minimum safety distance changes accordingly (the faster the movement, the longer the distance).

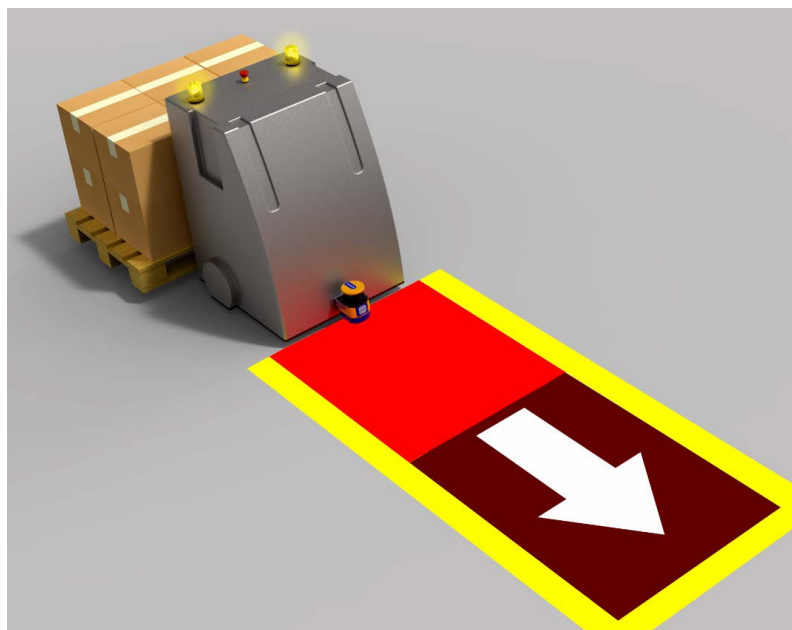

Figure 19 - AGV application

To meet such requirements, the SLS-M5-E-1708 model is equipped with encoder inputs that allow measuring the actual speed of the vehicle. Speed information is received from two independent encoders through their high-speed inputs supported by the 8-pole connector (pins 4, 5, 6, 8).



NOTE

Encoders with the following features must be used:

- Incremental encoders with A and B output signals, as shown in the figure below:

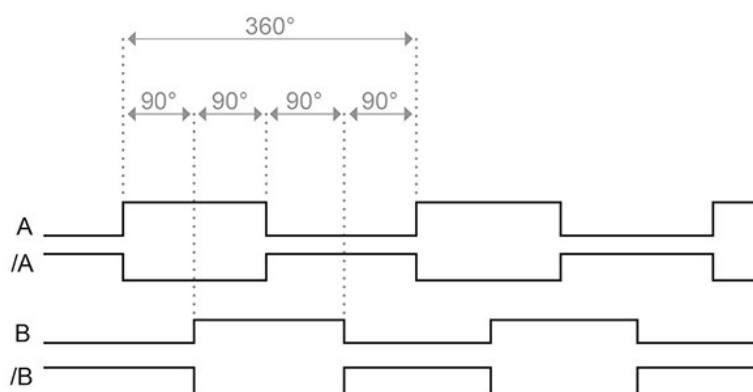

- Input max. frequency 100 kHz

The Laser Scanner receives the signals sent by the encoders to detect any object in the safety area by switching between the safety and warning areas associated with the vehicle. To this end, different zone sets must be configured so that each one of them will be activated by means of the inputs dedicated to the area switch. The number of available

zone sets depends on the number of available inputs. The maximum number of zone sets is 70.

Each zone set can be composed as follows:

CASE A	CASE B	CASE C
1 Safety area 2 Warning areas (optional) 1 Muting area (optional)	2 Safety areas 1 Warning area (optional) 1 Muting area (optional)	3 Safety areas 1 Muting area (optional)
Outputs needed		
2 Safety outputs (OSSDs) 2 Standard outputs	4 Safety outputs (OSSDs) 1 Standard output	6 Safety outputs (OSSDs)



NOTE

In case of a Master-Slave system, the zones designed for all the scanners must be considered.

To configure the necessary zone sets for a dynamic application, enable the encoder function in the Zone Set configuration page on DLSentinel.

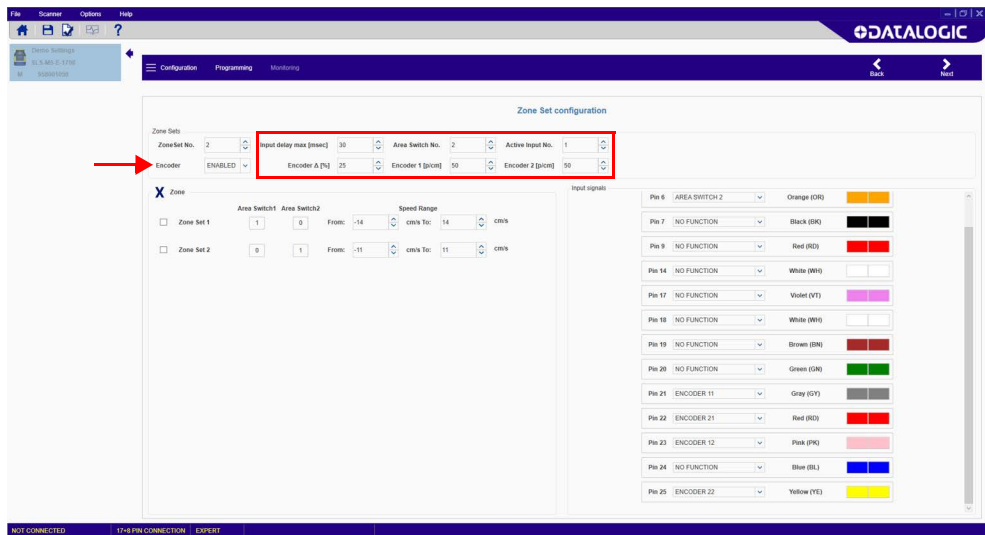

Input Delay Max [msec]

This parameter is valid when there are at least two Zone Sets. It determines the delay to apply between switching from one Zone Set to the next. The input delay allows waiting for the Area Switching inputs to stabilize from their transient states before accepting the Zone Set. Otherwise the activation and deactivation of the inputs could put the device in undesired or invalid and temporary switching zone input combinations and therefore cause the device to enter the fault state.

The minimum input delay (default) value is 30 msec. It can be increased in 30 msec increments.

Area Switch No.

Sets the number of Areas Switches, i.e. the univocal input combinations that make the Zone Sets change.

Active Input No.

Sets the number of available Active Inputs. This value can be increased according to the number of Area Switches.

Encoder Δ [%]

This is the allowable variation in the speed measures collected by Encoder 1 and Encoder 2. The minimum value is 0%, the maximum value is 45%, the default value is 25%.

To calculate the allowable variation for your application, use the following formula:

$$[(V_{\max} - V_{\min}) / V_{\min}] * 100$$

Where:

V_{\max} = maximum speed

V_{\min} = minimum speed

If the Encoder Δ is exceeded, the OSSDs enter the OFF status to stop the vehicle.

Exceeding the Encoder Δ is only allowed within a certain time window, based on the vehicle speed:

- If the vehicle speed is in the range between -10 cm/s and +10 cm/s, the vehicle will not be stopped, regardless of how long the Encoder Δ persists.
- If the vehicle speed is in the range between -30 cm/s and -10 cm/s or +10 cm/s and +30 cm/s, the Encoder Δ can be exceeded for max. 60 s.
- If the vehicle speed is in the range ≤ -30 cm/s or $\geq +30$ cm/s, the Encoder Δ can be exceeded for max. 20 s.
- If the vehicle speed is in the range ≤ -10 cm/s or $\geq +10$ cm/s, then different directions of rotation on the encoder are only tolerated for max. 0.4 s.



NOTE

When the speed measured by the two encoders is not the same, the higher speed value is used as a reference for this calculation.

Encoder 1 / 2 [p/cm]

Encoder (1 and 2) pulse number per centimeter. For both encoders the minimum value is 50 (default), and the maximum value is 1,000.

This is based on the number of pulses the encoder supplies per revolution, and on the ratio between the vehicle wheel and the friction wheel on which the encoder is mounted.

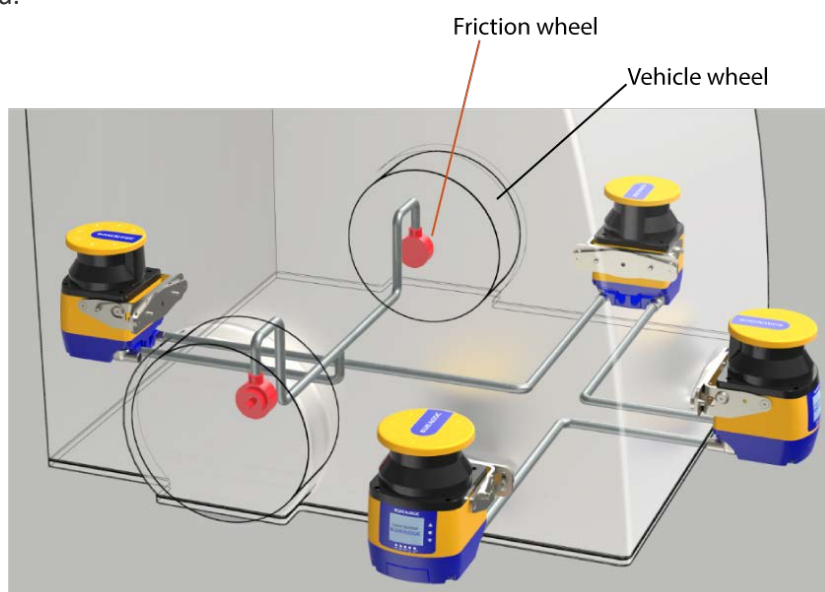

To calculate this value, follow the example below:

- The vehicle wheel has a diameter of 40 cm.
- The friction wheel on which the encoder is mounted has a diameter of 4 cm.

- The incremental encoder supplies 1000 pulses per revolution.

The circumference of the vehicle wheel is $40 \text{ cm} \times \pi = 125.66 \text{ cm}$.

One revolution of the vehicle wheel corresponds to 10 revolutions of the friction wheel, and therefore the encoder supplies 10,000 pulses per revolution of the vehicle wheel.

To calculate the Encoder Ratio (EncR), i.e. number of pulses per centimeter of distance covered by the vehicle, use the following formula:

$$\text{EncR} = P_{\text{rev}} / C$$

Where:

P_{rev} = pulses per revolution of the vehicle wheel

C = circumference of the vehicle wheel

In the example above, the EncR value is $10,000 / 125.66 = 79.58 \text{ p/cm}$. Therefore, on DLSentinel the rounded value “80” must be entered in the relevant **Encoder [p/cm]** field. The software will calculate the max. allowed speed based on this data.

After setting the encoder values, the Zone Sets must be configured.

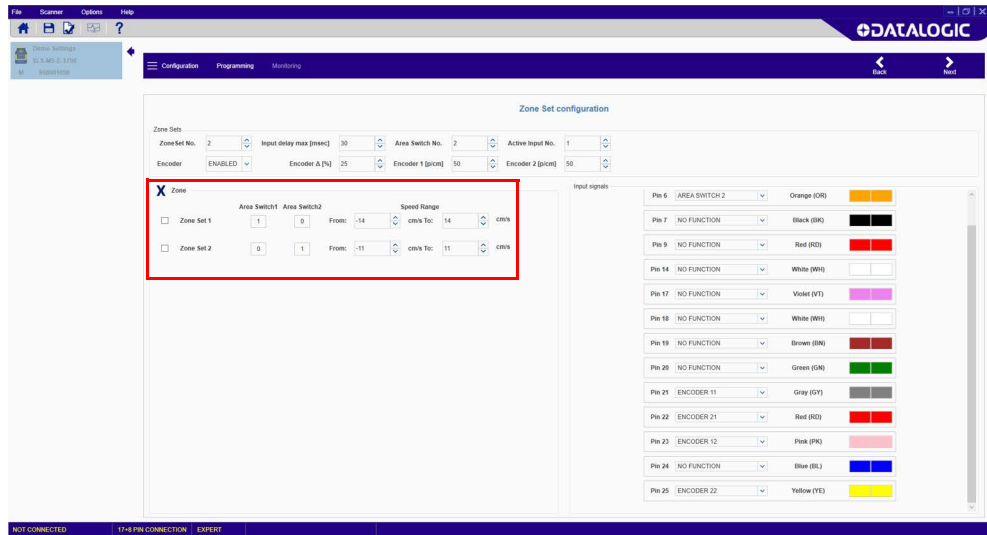

Zone

This parameter group allows editing the Area Switch input combinations depending on the number of selected Zone Sets and the Speed Range of each Zone Set.

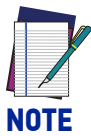

NOTE

If a different input switch coding is configured for each Area Switch, the relevant Zone Sets can have either overlapping or different Speed Ranges. In this case, all Area Switches must differ by two input bit states (Hamming distance) to be valid.

On the other hand, if more Area Switches share the same input switch coding, different Speed Ranges must be configured for each Zone Set.

To set valid Speed Ranges for each Zone Set, the user first needs to calculate the maximum and minimum speeds that the Safety Laser Scanner can read.

To calculate the maximum speed (V_{max}), use the following formula:

$$V_{\text{max}} = F_{\text{max}} / \text{EncR}$$

Where:

$F_{\text{max}} = 100,000$. This is a fixed value corresponding to the maximum frequency that the Laser Scanner can read.

EncR = Encoder Ratio, i.e. the number of pulses supplied by the encoder per centimeter of distance covered by the vehicle.

To calculate the minimum speed (V_{\min}), use the following formula:

$$V_{\min} = - F_{\max} / \text{EncR}$$

After calculating V_{\max} and V_{\min} of both encoders, take the lower values as a reference. The Speed Ranges of each Zone Set must not exceed these V_{\max} and V_{\min} values.

Example:

Encoder 1 ratio = 50 p/cm

$$V_{\max} 1 = 100,000 / 50 = 2,000 \text{ cm/s}$$

$$V_{\min} 1 = -100,000 / 50 = - 2,000 \text{ cm/s}$$

Encoder 2 ratio = 60 p/cm

$$V_{\max} 2 = 100,000 / 60 = 1,667 \text{ cm/s}$$

$$V_{\min} 2 = - 100,000 / 60 = - 1,667 \text{ cm/s}$$

Therefore, the maximum and minimum speeds that the Safety Laser Scanner can read equal respectively 1,667 cm/s and -1,667 cm/s. The Speed Ranges of each Zone Set cannot exceed these values.



NOTE

The Speed Range values cannot be included within the interval from -10 to +10.

For example, the Speed Range interval from -50 to -9 is not allowed, while the interval from -50 to +10 is allowed.



NOTE

If the encoder function is disabled after configuring the Zone Sets, these will be preserved, and the user will only have to set a valid code combination for each one of them.



NOTE

To avoid the flickering effect (continuous switching between two different Zone Sets), the user will have to consider a suitable margin between the speed ranges of different Zone Sets, as illustrated in the figure below.

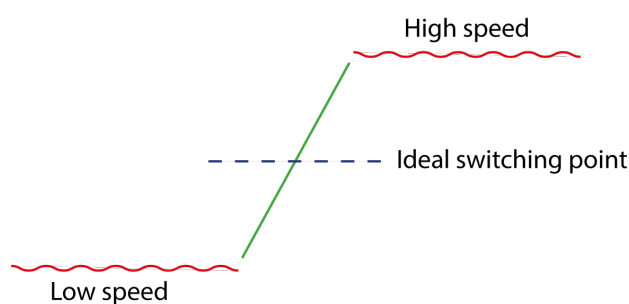

NOTE

Connecting cables must be laid to the encoders separately and suitably wired as to avoid opposite sign phases.

ANTI-INTERFERENCE CODING

Anti-interference coding allows using four different emission modes to minimize interference among scanners working in the same environment.

If scanners interfere with each other, a different code for each scanner can be selected. This function is also available for all connected devices in a Master Slave configuration.

The available codes are:

- Code 0
- Code 1
- Code 2
- Code 3

Code 0 is the default code.

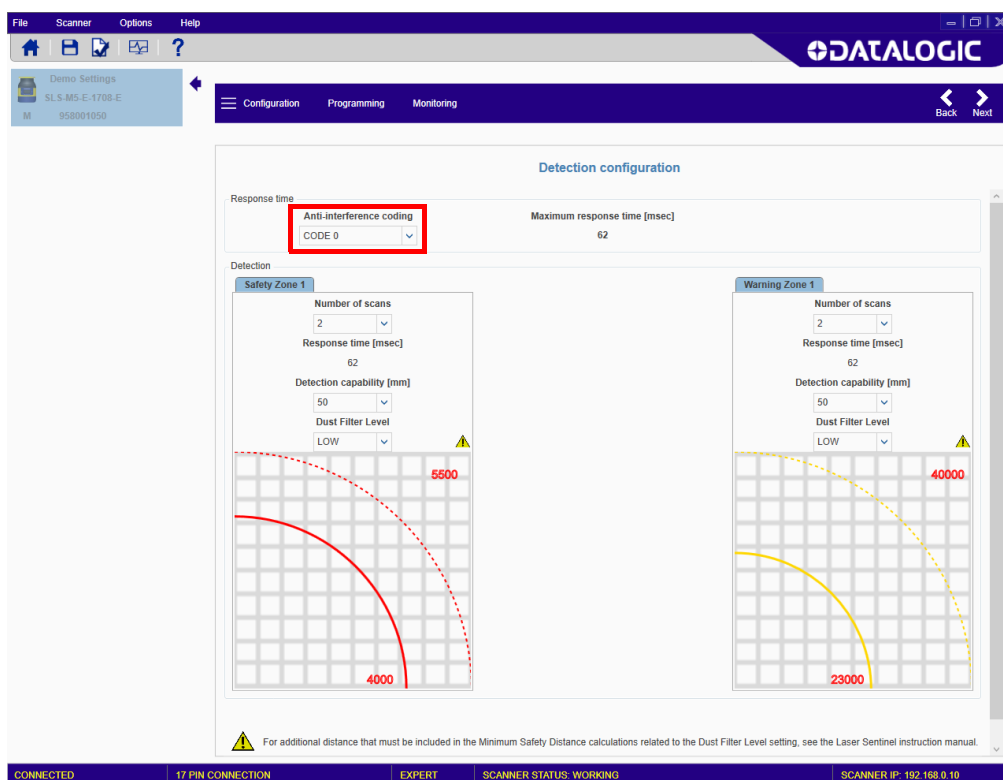

The selected code has an impact on the response time of the relevant device (see "Response Time and Scan Cycle Setting" on page 66), in particular it changes the scan cycle time as indicated in the table below:

ANTI-INTERFERENCE CODE	SCAN CYCLE TIME
0	30 ms
1	30.5 ms
2	31 ms
3	31.5 ms

DUST FILTERING

The Dust Filter Level must be set according to different conditions specific to the application. In general, it is the sensibility to various levels of airborne particles that impact the response of the Laser Sentinel detection.

A **Low** Dust Filter Level (default) is used in cleaner environments where airborne particles have little effect on object detection.

A **High** Dust Filter Level is used in dirty environments to filter (ignore) detection of airborne particles from being confused with objects to detect. The Laser Sentinel is less sensitive to dust and therefore avoids shutting down the machinery unnecessarily.

This parameter should be set to the lowest value that still allows the machinery to work without detections due to dust.



NOTE

A Low Dust Filter Level could also prevent light interference and reflecting background influences from reducing the device detection capability. Refer to "Light Interference" on page 12 and "High Reflecting Background" on page 13 for more details.

SHUT OFF

The Shut Off function allows energy saving, which can be particularly useful when the Safety Laser Scanner is used in battery-powered applications (e.g. AGV).

When the Safety Laser Scanner is in Shut Off status, some of its functions are deactivated, but the device is still active and ready to restore to normal operation when needed.

DLSentinel does not allow the user to update firmware version, change configuration, or set parameters (e.g. IP address, password) when the device is in Shut Off status.

To enable the Shut Off function on DLSentinel, go to the Zone Set configuration page. After enabling the function, Zone Set 1 turns into Shut Off: this zone set cannot have any Safety or Warning Area, and the encoders speed range is set to 0.

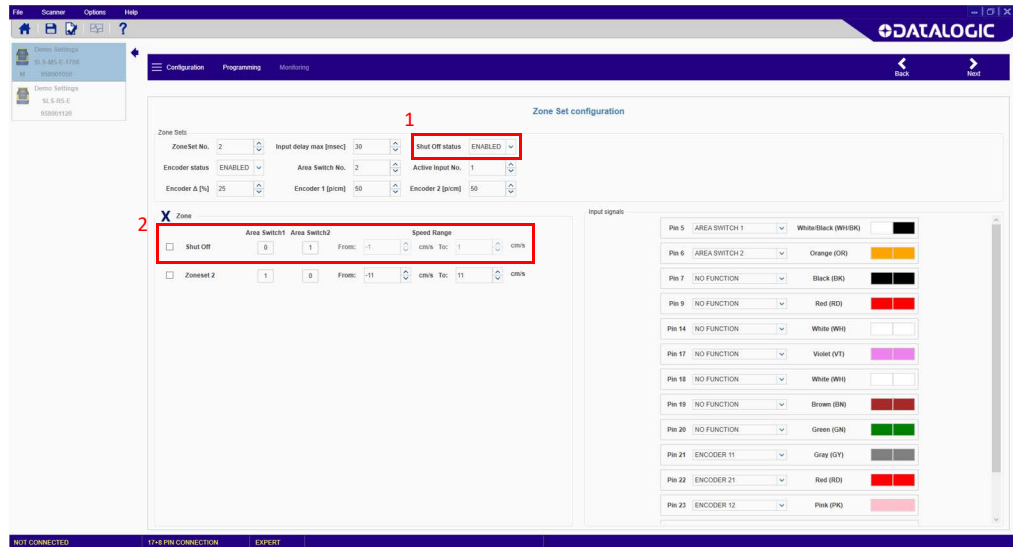

When the Shut Off function is enabled, the SLS display will show an icon for 30 seconds. After that, the display will switch to power safe mode, and all LEDs will go off.

To restore to normal operation, the zone set must change. In this case, the Safety Laser Scanner needs approx. 30 seconds to reactivate all its functions. The display and the LEDs will indicate that the scanner is back to normal operation.



NOTE

If the Shut Off function is disabled after drawing the Safety areas, these will be deleted.



NOTE

When a cluster in Shut Off status is switched off and one of its Slave devices is disconnected (e.g. for maintenance), a particular case arises if the cluster is switched on again: the INTF18 topology error message will be displayed while the cluster is still in Shut Off status. To solve this situation, switch off the cluster, change the input configuration to exit the Shut Off status, then switch on the cluster again. The Master will show the INTF18 topology error message, while the Slave devices will be in normal operation. Now the user is allowed to change the cluster topology.

RESET

Reset is a function that allows restoring normal operation after a failure lockout condition, due to system error, without disconnecting the power supply.

The aim of the Reset is to return the system to a power-on phase, by resetting all the variables and starting a new integrity test session.

The minimum pulse width of the Reset function is 500 ms (constant value). If the width is less than the required value, then the Reset function will not be activated. To activate the Reset function, the push-button (switch), connected between 24 Vdc and the Reset input, must be pressed and held for at least 500 ms (non-critical failure status).

Auto Reset

DLSentinel allows the user to activate the Auto Reset function following a diagnostic fault.

If the Auto Reset is enabled, SLS will automatically reset after 10 seconds from the error condition and will resume normal operation.

The Auto Reset function will be permanently inhibited if the device locks in INTFx more than 5 times within 15 minutes. In this case a power cycle is necessary to reactivate the SLS.



NOTE

If the error is not solved, the device will return to the lockout failure condition again.



NOTE

The Reset or Auto Reset functions may not restore the lockout status of the device; in this case a power cycle is necessary.

WINK

Wink is a function that allows recognizing which device is to be configured from those available on the Network.

The Wink function can be activated through the discovery by clicking on the wink button, and then the Wink icon will be displayed.

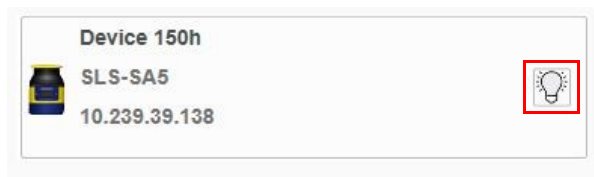

Figure 20 - GUI Wink button



Figure 21 - Wink displayed icon

SAFETY REPORT GENERATION AND ACCEPTANCE

The Safety Report is a file that sums up all the parameters selected for a configuration and is generated by the GUI after creating a configuration.

The Report file is displayed on the right side of the panel. It is possible to save it as a PDF file and print it.

Follow the steps below to create the Report file:

1. Once the configuration has been created or loaded, enter the **Programming** function.
2. Upload the configuration in **Configuration Upload**. The **Report** file is generated by the GUI. Make sure to read and check all the selected parameters.
3. Then test its functioning by entering **Monitoring**.
4. After testing the configuration in **Monitoring** and checking the **Report** accept or reject the configuration in **Validation**.



By validating the configuration, you take on responsibility for the created configuration accepting the hazard due to configuration errors.

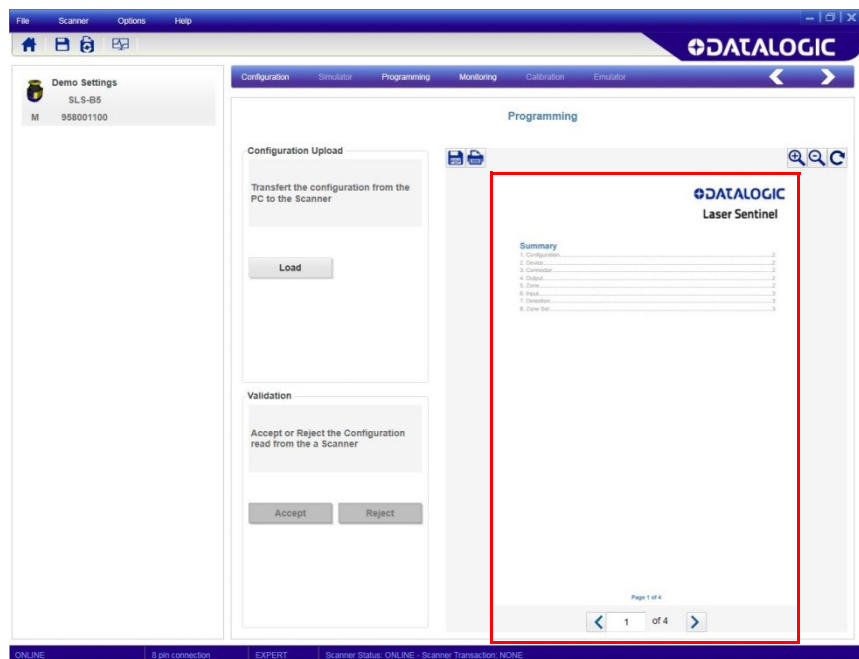





CHAPTER 9









DIAGNOSTICS





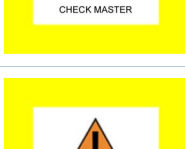
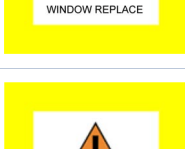

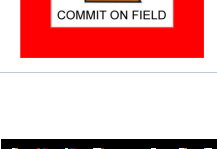

MONITORING BY DISPLAY









DISPLAYED ICON		NAME	DESCRIPTION
Configuration valid	Configuration pending acceptance		
		ON State	The device is correctly functioning (OSSDs GO Condition). No presence detected in the Safety and Warning Area.
		Warning for intrusion into Warning Area	The device is correctly functioning. The device has detected a presence in the Warning Area.
		OFF State for intrusion into Safety Area	The device is correctly functioning (OSSDs STOP Condition). The device has detected a presence in the Safety Zone.
		OFF State for Reference Points	The device has detected that Reference Points have moved. The Display Sector in the direction of the moved reference point is lit in blue.











DIAGNOSTIC NOTES, WARNINGS, AND ERRORS

DISPLAYED ICON	DISPLAYED FAULT CODE	DEVICE STATUS	OSSD STATUS	DESCRIPTION
	DLDNF	NORMAL	OFF	Downloading new firmware.
	DLDNC	NORMAL	OFF	Downloading new configuration.
	CLEANW2	NORMAL	ON	It is suggested to clean the window to avoid entering lockout condition.
	ITLOCKx	NORMAL	OFF	Interlock. Waiting for the relevant OSSD pair to restart.
	INTF6	NORMAL	ON	Micro integrity test failure. Internal peripheral test for non safety relevant functions.
	BOOTF	NORMAL	OFF	Invalid boot. Re-boot the system until the normal condition is restored. If warning persists, contact our Technical Support.
	MUT TIMEOUT	NORMAL	ON	Muting has expired because it is maintained beyond the maximum timeout time.
	MUTING ERR	NORMAL	ON	Muting has not activated because the correct sequence was not followed.
	MUTING	NORMAL	ON	The Muting function is active.
	OVERRIDE ERR	NORMAL	ON	Override has not been activated because the correct sequence has not been followed or there are no override conditions.

DISPLAYED ICON	DISPLAYED FAULT CODE	DEVICE STATUS	OSSD STATUS	DESCRIPTION
	OVERRIDE	NORMAL	ON	The Override function is active
	OVERTEMP	NORMAL	ON	The external temperature is above the limit.
	OVR TIMEOUT	NORMAL	ON	The Override timeout function has expired.
	HIGH REFL-BKG	NORMAL	ON	A high reflecting background is detected that could have an impact on detection capability. Take the measures described in " Precautions for Environmental Interference " on page 11 or reduce/remove the reflecting background.
	CHECK MASTER	NORMAL	ON	The Slave unit warns against a problem on the Master device.
	WINDOW REPLACE	NORMAL	OFF	Window replacement procedure in progress.
	WR FAILED	LOCKOUT	OFF	Window calibration failed. Repeat the procedure or change the window.
	COMMIT ON FIELD	NORMAL	OFF	The device needs a commit when it has been restored on field after window replacement.
	SHUT-OFF	NORMAL	OFF	Shut Off function enabled.
	RES SHUT-OFF	NORMAL	OFF	Shut Off function disabled.

DISPLAYED ICON	DISPLAYED FAULT CODE	DEVICE STATUS	OSSD STATUS	DESCRIPTION
	WAITING CONF	LOCKOUT	OFF	The device is waiting the first configuration (e.g. after a Factory Reset)
	CLEANW1	NORMAL	OFF	Window needs to be cleaned. Repeat this action until the normal condition is restored. Otherwise contact our Technical Support to replace the damaged part.
	INPUTCF1	LOCKOUT	OFF	Invalid input configuration or connection.
	INPUTCF2	LOCKOUT	OFF	Invalid input transition.
	OSSDF1	LOCKOUT	OFF	OSSD integrity test failure.
	OSSDxF3	LOCKOUT	OFF	OSSDx overcurrent or short circuit.
	INTFx	LOCKOUT	OFF	Internal Failure. Reset the system by using the reset function or cycle power to device. If failure persists, contact our Technical Support.
	INTF18	LOCKOUT	OFF	Internal Failure. Reset the system by using the reset function or cycle power to device. If failure persists, contact our Technical Support. This fault also occurs when a device of the Master/Slave cluster is replaced or removed (Topology fault). In this case, connect to the GUI and upload a new configuration.
	INTF20	NORMAL	OFF	Master/Slave connection failure. Check network connector or the integrity of Slave devices and restore normal network operation. If failure persists, contact our Technical Support.

DISPLAYED ICON	DISPLAYED FAULT CODE	DEVICE STATUS	OSSD STATUS	DESCRIPTION
	ENC OUT OF FREQ	LOCKOUT	OFF	The input received from Encoder 1 or Encoder 2 exceeds the maximum pulse frequency. The device enters lockout status after three consecutive events.
	ENC ERROR	LOCKOUT	OFF	This error can occur if one of the following conditions is met: <ul style="list-style-type: none"> •The difference between the speed measures collected by Encoder 1 and Encoder 2 exceeds the Encoder Δ beyond the allowable time window. •The encoders are not connected properly.
	SLAVE ERROR	LOCKOUT	OFF	The Master device warns against a fault or error condition in a Slave unit.
	EDM	LOCKOUT	OFF	EDM error. Check the connection of the EDM wire and verify if the setting of the delay match with the characteristics of the relay then, if necessary, replace the relay. If the error persists, contact our Technical Support.
	ANTITAMPERING	LOCKOUT	OFF	The Anti-Tamper function has been activated (see "Anti-Tamper Function" on page 100).
	MG NO MATCHING	BOOT	OFF	Memory Group does not match with the configuration. Replace the Memory Group with the right model.
	MG FAILURE	BOOT	OFF	Memory Group failure. Create a new configuration via GUI, perform a backup configuration from the Master device, or replace the Memory Group.
	MG EMPTY	BOOT	OFF	The Memory Group has no configuration stored on board. Create a new configuration via GUI or perform a backup configuration from the Master device.
	DEVICE EMPTY	BOOT	OFF	The Master device has no configuration stored on board. Create a new configuration from GUI or restore the configuration from the Memory Group.

DISPLAYED ICON	DISPLAYED FAULT CODE	DEVICE STATUS	OSSD STATUS	DESCRIPTION
	CFG NO MATCHING	BOOT	OFF	The device configuration does not match with the Memory Group configuration. Follow the displayed instructions.
	INCOHERENCE	BOOT	OFF	The device found an incoherent configuration. A new configuration via GUI is necessary.
	BKP IN PROGRESS	BOOT	OFF	Fast replacement backup phase in progress. Wait and do not push any button.
	BKP DONE	BOOT	OFF	Fast replacement backup phase completed.
	BKP FAILED	BOOT	OFF	Fast replacement backup phase failed. Try again or create a new configuration via GUI.
	RES IN PROGRESS	BOOT	OFF	Fast replacement restore phase in progress. Wait and do not push any button.
	RESTORE DONE	BOOT	OFF	Fast replacement restore phase completed.
	RES FAILED	BOOT	OFF	Fast replacement restore phase failed. Try again or create a new configuration via GUI.
	RES VALIDATION	BOOT	OFF	The fast replacement restore phase needs validation by the user to go back to normal operation after checking that the safety conditions have been restored.
	RES ABORT	BOOT	OFF	If the safety conditions have not been restored after the fast replacement restore phase, the user can abort the restore phase and create a new configuration via GUI.

ANTI-TAMPER FUNCTION

The SLS continually monitors for conditions caused by tampering in the work area and/or the device itself that may create interference or improper operation leading to a potential loss or reduction of the safety function.

Once these conditions are found, the device is forced to STOP and the display indicates this until the conditions cease.



The function has been made selectable from DLSentinel for flexibility of use in various application scenarios.



Disabling the function or selecting an activation delay time longer than 5 s (if you want to keep the function enabled) must be carefully evaluated by qualified personnel in charge of machine safety through a specific risk analysis, which could lead to the introduction of additional safety measures.

In particular, if the function is enabled by selection from DLSentinel, the forced STOP state is activated within the set delay time from when the device does not receive a return signal (echo) powerful enough to be processed on at least 700 consecutive beams of the scanning path (equal to or greater than an angular sector of 70°).

The forced STOP state ends within 120 ms as soon as the mentioned condition ceases for at least 50 consecutive beams (equal to or greater than a 5° angular sector) of the 70° considered.

This condition occurs in various situations in the application field. The most common ones are described below.

1. No objects are present up to the maximum working distance of 50 m over a portion of the scanning area (e.g. open field scanning).
2. Objects are present even at distances less than 50 m on a portion of the scanning area, but their reflectivity property is such that they do not generate appreciable echoes. For example, very dark and opaque objects (as a reference, objects with 1.8% reflectivity may not be detected if placed at distances greater than 8-10 m; objects with 18% reflectivity may not be detected if placed at distances greater than 22-25 m).
3. The window of the device is accidentally obscured (e.g. with a cloth) within the limited detection zone, partially or totally hindering the field of view.
4. There are highly reflective surfaces in the scanning area (e.g. mirrors, polished surfaces, windows) positioned in such a way as to divert the trajectory of incident beams out of the device's reception range.

SAFETY



WARNING

Hazard due to lack of effectiveness of the safety device.

Operators to be protected may not be recognized in case of nonobservance.

- Immediately put the machine out of operation if the behavior of the machine cannot be clearly identified.
- Immediately put the machine out of operation if you cannot clearly identify or locate the fault, or if you cannot safely remedy the fault.
- Secure the machine such that it cannot be switched on unintentionally.



WARNING

Hazard due to unexpected starting of the machine.

- When any work is taking place, use the protective device to secure the machine or to ensure that the machine is not switched on unintentionally.



WARNING

Hazard due to lack of effectiveness of the protective device.

Operators to be protected may not be recognized in case of nonobservance.

- Do not carry out any repairs to the device components.
- Do not make any changes to or tamper with the device components.
- Except for the procedures described in this document, the device components must not be opened.



NOTE

If you cannot remedy the fault with the help of the information provided in this chapter, please contact our Technical Service.

LEDs AND DISPLAY









The safety laser scanner is equipped with three lateral buttons, a graphical display and four status LEDs located below the display.

Diagnostic and Status LEDs

The safety laser scanner has diagnostic LEDs for initial diagnostics.

The OFF state and ON state LEDs can be found below the safety laser scanner display.

When it is not possible to see the display, e.g. due to mounting or because it is hidden from the operator's viewpoint, check the GUI status (**Monitoring**).

	LED 1: assigned to safety zone 1 (red indicates object detection in safety zone 1; green indicates that no presence is detected in safety zone 1).
	LED 2: assigned to safety zone 2 (red indicates object detection in safety zone 2; green indicates that no presence is detected in safety zone 2).
	LED 3: assigned to safety zone 3 (red indicates object detection in safety zone 3; green indicates that no presence is detected in safety zone 3) or warning zone 2 (amber indicates object detection in warning zone 2, off indicates that no presence is detected in warning zone 2)
	LED 4: assigned to warning zone 1 (amber indicates object detection in warning zone 1, off indicates that no presence is detected in warning zone 1)
	LED 5: Interlock (amber indicates that the Interlock function is active).
	Button 1: to browse quickly the Menu functions (up).
	Button 2: to enter and confirm the selected Menu function.
	Button 3: to browse quickly the Menu functions (down).

Display Menu

To enter the Display Menu, push the squared button. By using the up and down arrows button, it is possible to browse the menu. To select an area, press the squared button. To exit every menu option, push the squared button after selecting it.

The menu is divided into three main areas: Information, Settings and Exit:

INFORMATION	
Hardware	Device Name
	Model Code
	Part Number
	Serial Number
	Firmware Version
	Device Lifetime (h): shows the device lifetime in hours
Configuration	Configuration Name
	Safety Signature
	Last Conf. Date: shows the date of the last configuration
	Main IP Address
	MAC Address
SETTINGS	
Display Settings	Rotate: rotates the screen depending on the device position
Reset SLS	Restores normal operation after a failure lockout condition (for more information, see "Reset" on page 91)
EXIT	

Diagnostics Using the Display

The display supplies information about the status of the safety laser scanner, and for diagnostics and troubleshooting.

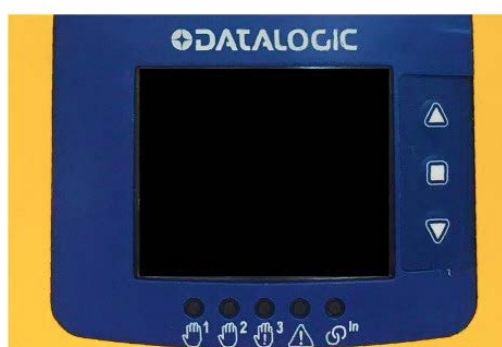

NOTE

The refresh rate of the display is slower than the switching rate of the OSSD output. Therefore, it may occur that the display may not be synchronized with the OSSD output in the case of rapidly switching states.

DIAGNOSTIC LOG

Several categories of events (regarding the Master and the Slave devices) are logged into a specific file saved both in the Memory Group and the Master device.

To view the events occurred to your device(s), launch DLSentinel, discover your device or cluster, then go to **Scanner > Read from scanner > Open log from memory scanner**.

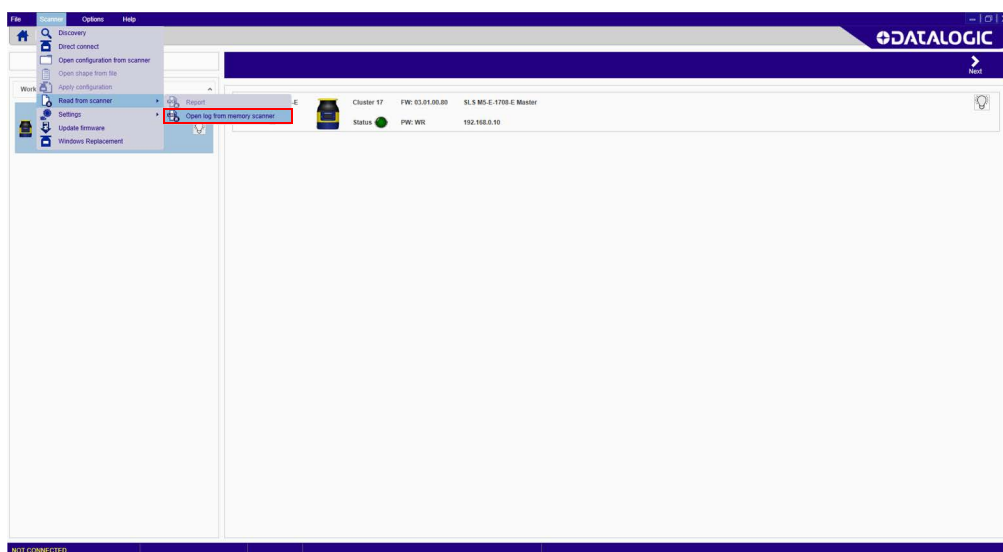

After entering the password, DLSentinel will inform you that the device will switch to Off Duty status. Click **OK** to continue.

A log file in .csv format will be created. DLSentinel will prompt you to select a folder where the log file will be saved.

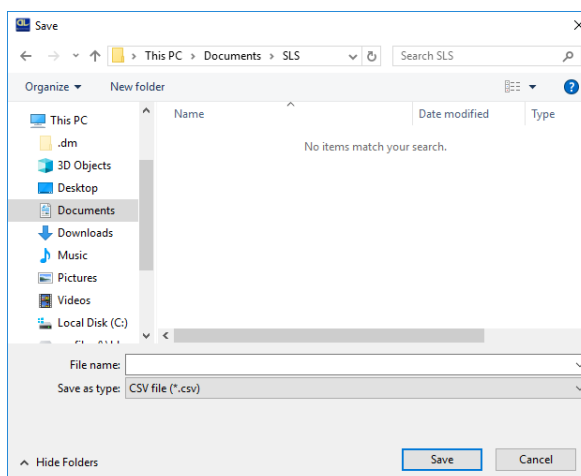

After clicking **Save**, the following information window is displayed:

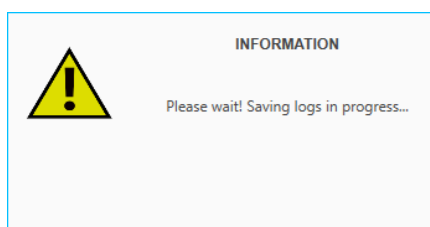

Once the log file creation is completed, the following information window is displayed:

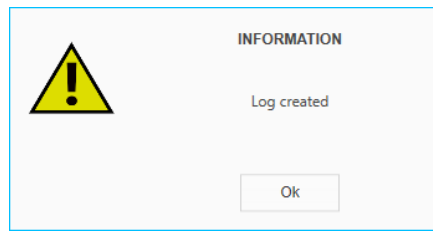

You can now view your log file.

TIME STAMP;TYPE OF LOG;DESCRIPTION
12-Sep-19 6:25:28 PM;FAULT; FAULT INPUTCF2
12-Sep-19 6:25:16 PM;UPDATE; UPDATE POWER RESET
12-Sep-19 6:23:08 PM;FAULT; FAULT INPUTCF2
12-Sep-19 6:22:57 PM;UPDATE; UPDATE POWER RESET
12-Sep-19 6:21:10 PM;OUTPUT; INTRUSION NODE:3 SAFETY1 Cluster:8
12-Sep-19 6:21:06 PM;OUTPUT; INTRUSION NODE:1 SAFETY1 Cluster:11
12-Sep-19 6:20:26 PM;OUTPUT; INTRUSION NODE:0 SAFETY1 Cluster:8
12-Sep-19 6:19:36 PM;OUTPUT; INTRUSION NODE:0 SAFETY1 Cluster:8
12-Sep-19 5:57:04 PM;OUTPUT; INTRUSION NODE:0 SAFETY1 Cluster:8
12-Sep-19 5:57:03 PM;OUTPUT; INTRUSION NODE:0 SAFETY1 Cluster:7
12-Sep-19 5:56:14 PM;OUTPUT; INTRUSION NODE:0 SAFETY1 Cluster:9
12-Sep-19 5:56:13 PM;OUTPUT; INTRUSION NODE:0 SAFETY1 Cluster:9
12-Sep-19 5:01:58 PM;OUTPUT; INTRUSION NODE:0 SAFETY1 Cluster:8
12-Sep-19 4:51:00 PM;OUTPUT; INTRUSION NODE:0 SAFETY1 Cluster:8

Figure 1 - Log file example

The following categories of logged events are included:

- Output events (intrusions into safety areas)
- Input events (Muting and Override events)
- Fault events
- Update events (e.g. new firmware, new configuration, etc.)
- Fast Replacement events
- Zone Set selection events
- Window Replacement events

Generally, the format of an event is as follows:

<Date> <Time>;<Type of Log>;<Event description>

For example, a Fault event is described as follows:

12-Sep-19 6:25:28 PM;FAULT;FAULT INPUTCF2

PERIODICAL CHECKS

The following list includes recommended check and maintenance operations that should be periodically carried out by qualified personnel.

- The Laser Sentinel is installed with all the correctly fixed mounting components, without any change on its position: Safety distance is ensured and the detection plane has also not changed.
- The optical window is not dirty or damaged (for more information, refer to "[Window Cleaning](#)" on page 108).
- All electrical connectors are correctly fastened and the cable wires are correctly connected to external device.
- If the laser Sentinel is operating in automatic start mode, make sure that the machine stops and does not restart when the test object is in the safety zone.

The frequency of checks depends on the particular application and on the operating conditions of the Laser Sentinel.

If any of these checks are not verified, it is not allowed to continue to work on the machine. In this case the installation of the laser Sentinel must be checked by qualified safety personnel and tested following the "CHECKS AFTER FIRST INSTALLATION" procedure as indicated.

CHAPTER 10

DEVICE MAINTENANCE

GENERAL INFORMATION AND USEFUL DATA

The Laser Sentinel does not include any repairable components; avoid repairing or replacing device parts not mentioned in this manual. Failing to observe this instruction may cause malfunction due to severe device damage.



Use of controls or adjustments or performance of procedures other than those specified herein may result in hazardous radiation exposure.

WINDOW CLEANING

The Laser Sentinel optical window needs periodical cleaning, and the frequency depends on the type of environment in which the device operates.



CAUTION

Contamination of the optical window (due to dust, oil, etc.) in the presence of background reflection may impair the detection capability of the safety laser scanner. Always keep the optical window free from contamination.



CAUTION

The device may present failure if the optical window is scratched or damaged. In case of abrasive particle deposits, make sure to rub gently against the window during cleaning to avoid any damage. If the window is scratched, window or device replacement is recommended.

It is recommended to use the anti-static cleaner (SLS-CLEANER order no.95ASE2990) and the disposable cloths (SLS-CLOTH order no.95ASE3000) to remove dirt and dust deposits from the optical window.

Otherwise use a soft non-electrostatic cloth and a non-aggressive and non-abrasive cleaning agent.

In particular, the cleaning procedure depends on the kind of contamination:

CONTAMINATION	ACTION
Loose, abrasive particles	1. Vacuum without contact or gently blow away 2. Wipe free with cleaning cloth in one swipe
Loose, non-abrasive particles	Vacuum without contact or gently blow away OR Wipe away cleaning cloth in one swipe
Statically charged particles	1. Vacuum without contact 2. Wipe free in one swipe with cloth soaked in cleaning agent
Adhering particles	1. Wet with cloth soaked in cleaning agent 2. Wipe free with cleaning cloth in one swipe
Oil drops	
Fingerprints	
Water drops	Wipe free with cleaning cloth in one swipe
Deep scratches and cracks	Check detection capability. In case of failure, replace the window or the device

**NOTE**

It is necessary to clean the underside of the end cap (the black surface under the yellow cap on top of the scanner).



WINDOW REPLACEMENT

When a “Clean Window” error is shown on the device display even after cleaning the window, check for any scratches or spots. If the window is **scratched or spotted**, but not cracked (which would compromise the IP65 protection of the device), the user is allowed to replace the Laser Sentinel optical window.

Order the replacement window from Datasensing and carefully follow the procedure below.

In all other cases, please contact Datasensing for device repair or replacement.

Warning Terms - Disclaimer for Window Replacement and Calibration



WARNING

PLEASE READ CAREFULLY THIS STATEMENT. BY REPLACING AND CALIBRATING THE WINDOW, YOU ACKNOWLEDGE AND ACCEPT THE FOLLOWING WARNING TERMS.

Window replacement is allowed **solely when the optical window is scratched or spotted or in case of unresolvable “Clean Window” error**. You are kindly requested to check and comply with this section of the manual, where you can find all conditions, prerequisites, and terms according to which such procedure shall be performed.

The window replacement procedure is allowed provided that:

1. **you and your qualified personnel fully comply with the proper instructions set forth in this manual.** Instructions are technical and specific rules that shall be understood, acknowledged and applied by you and your qualified personnel;
2. **only qualified personnel, as defined below, will perform this procedure;**
3. window replacement is performed in a **clean environment** that shall be set up in accordance with "[Prerequisites for Window Replacement](#)" on page 111 to prevent any contamination of the internal optical surface;
4. **any dangerous procedure is interrupted and all safety sensors are disconnected,** including any system related to the product;
5. **the replacement window is not dirty or scratched and has never been used. Avoid any contamination (dirt, fingerprints, scratches, etc.) on or inside the new window during installation.**

For the avoidance of doubt, “qualified personnel” means those personnel who have a suitable technical education; who are acquainted with and are used to working in accordance with the rules and regulations for labor protection, safety at work and safety technology; and who keep their knowledge up to date through continuous training. Certified professionals could be involved in some activities; such certified professionals shall fulfill the requirements of accident prevention regulations to the extent applicable and as set forth by the applicable law.

With regards to window replacement, **you shall be, *inter alia*, responsible for:**

- **complying with the instructions** set forth in this manual;
- **training the qualified operator** accordingly;

- carrying out the activities under your accountability in a proper way and in compliance with the instructions provided herein;
- **maintaining the safe operation** of the product and the environment in which it is installed;
- **abiding by all regulations and directives for labor protection and safety at work;**
- **regularly having the product tested and calibrated by competent persons, who shall report any anomalies and track the performance of the product in written records, which shall be sent to Datasensing.**

BY REPLACING THE OPTICAL WINDOW, YOU DECLARE TO ACKNOWLEDGE AND ACCEPT THE POTENTIAL RISKS AND LIABILITIES ARISING FROM THE WINDOW REPLACEMENT PROCEDURE, AS WELL AS FROM FAILURE TO COMPLY WITH THE INSTRUCTIONS PROVIDED BY DATASENSING IN THIS RESPECT. TO THE FULLEST EXTENT PERMITTED BY LAW, DATASENSING (AND ITS DIRECTORS, OFFICERS, AFFILIATES) SHALL NOT BE HELD LIABLE FOR ANY DAMAGES (DIRECT, INDIRECT, OR CONSEQUENTIAL) WHICH MIGHT OCCUR TO YOU AND ANY THIRD PARTIES AS A CONSEQUENCE OF THE WINDOW REPLACEMENT PROCEDURE PERFORMED BY YOU OR YOUR QUALIFIED PERSONNEL.

Prerequisites for Window Replacement



NOTE

To perform the window replacement procedure, the following prerequisites must be strictly observed:

Clean environment	Avoid the window replacement on field. The optical window must be replaced in a controlled, pollution-reduced environment.
Non-condensing environment	The environment where the window replacement is performed must have a temperature of 18 – 30 °C and a non-condensing humidity (preferably < 80%).
Free area	A 2-meter free area around the 275° angle range of the Laser Scanner is necessary to calibrate and validate the new optical window.
Visual inspection	A visual inspection is needed before replacement to establish whether the optical window can be replaced or the whole device needs replacing instead.
Use of dedicated tools	To perform the window replacement procedure a 2.5 mm hex key is necessary, preferably with adjustable torque driver.
Skilled, authorized personnel	The replacement of the optical window must be performed by skilled, authorized personnel only.

Window Replacement Procedure

After establishing that the replacement of the optical window is necessary and after making sure that all above-mentioned prerequisites are met, start the window replacement procedure.

The new optical window package contains the following parts:

- 1 optical window;
- 1 seal;
- 4 Tuflok® screws.



When handling the new optical window, avoid contaminating it with fingerprints, dirt, scratches, dust, and polluting agents. It is recommended to wear clean, thin gloves to unpack and install the new window.

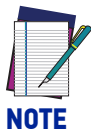

Always disconnect power to the Safety Laser Scanner before starting the window replacement procedure.

1. Place the Safety Laser Scanner on an even base in a controlled, pollution-reduced environment.

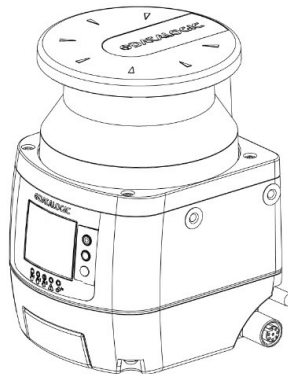

2. Remove the four screws fixed on the damaged optical window.

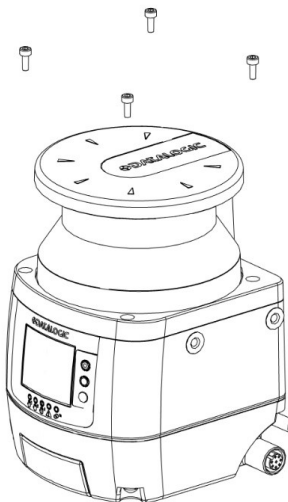

3. Remove the optical window with a linear, vertical movement.

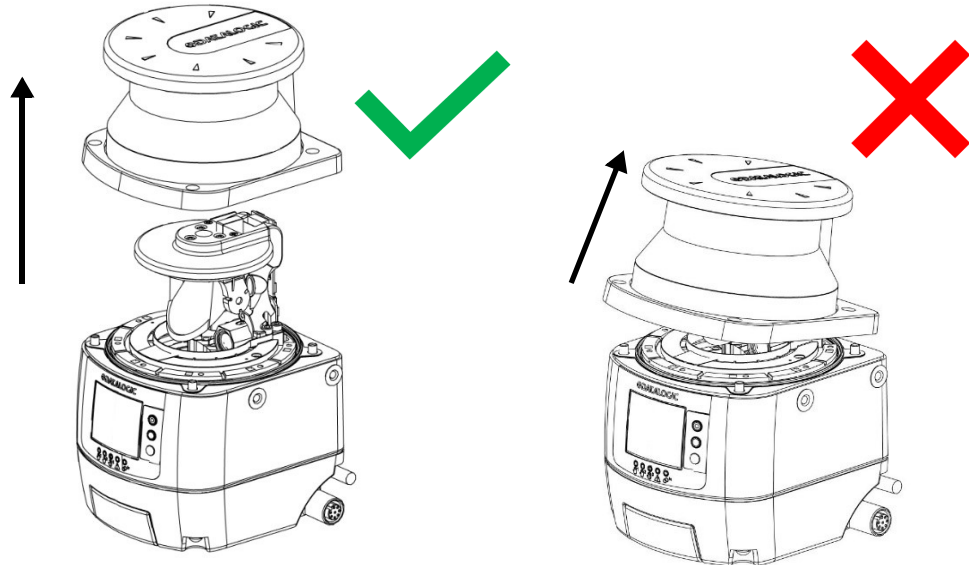

Take the utmost care to avoid touching or damaging the internal parts of the device.

4. Remove the seal positioned on the device body. Avoid touching or damaging the internal parts of the device.

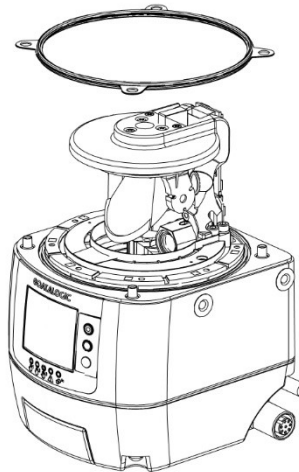

After removing the damaged window, avoid contaminating all the internal optical parts with fingerprints, dirt, scratches, dust, and polluting agents.

5. Position the new seal, gently pressing it on the device body and making sure it perfectly adheres to it.



CAUTION

Before closing the window, take sufficient measure to prevent dust and any polluting agent from entering the device, as this could affect the detection capability of the Safety Laser Scanner. In case of contamination, use dry compressed air to remove it.

6. Hold the new optical window on the sides and carefully place it in the correct position. Exert pressure on the angles and make sure that the window is perfectly attached to the device body without any inclination.

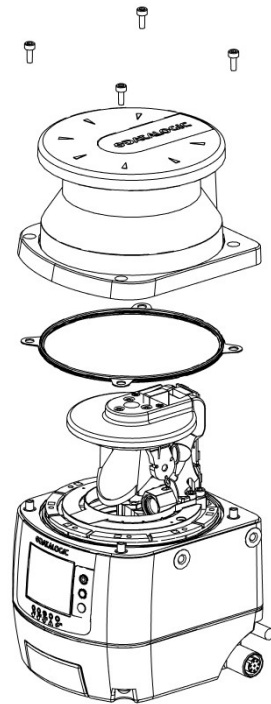

7. Snug the 4 Tuflok® screws down (do not overtighten them). Use a 2.5x100 ball-end hex screwdriver with a shank long enough to avoid damaging the optical window.

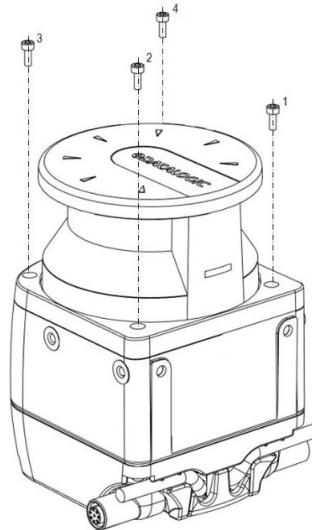

8. Tighten the screws with a torque wrench (tightening torque 0.6 Nm, bit 2.5 mm).
9. Remove any contamination (e.g. fingerprints, dust, etc.) on the optical window.



NOTE

After replacing the window, always perform window calibration to guarantee proper working of the device.

New Window Calibration

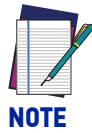

NOTE

A 2-meter free area around the 275° angle range of the Laser Scanner is necessary to calibrate and validate the new optical window. Keep this area free for the whole duration of the procedure.



NOTE

If the Window Replacement procedure is performed on a Slave device, this must be connected to a Master device. In this case, the last configuration is preserved only if the optical window is replaced while the Slave device is connected to the same Master device of said configuration. On the other hand, if the Slave device is connected to a different Master device during Window Replacement, the last configuration will be lost.

10. After replacing the optical window, supply power to the Safety Laser Scanner and connect it to DLSentinel.
11. On DLSentinel, discover your device. On the Discovery page, go to *Scanner>Window Replacement* and enter your password (if any), then start the procedure.

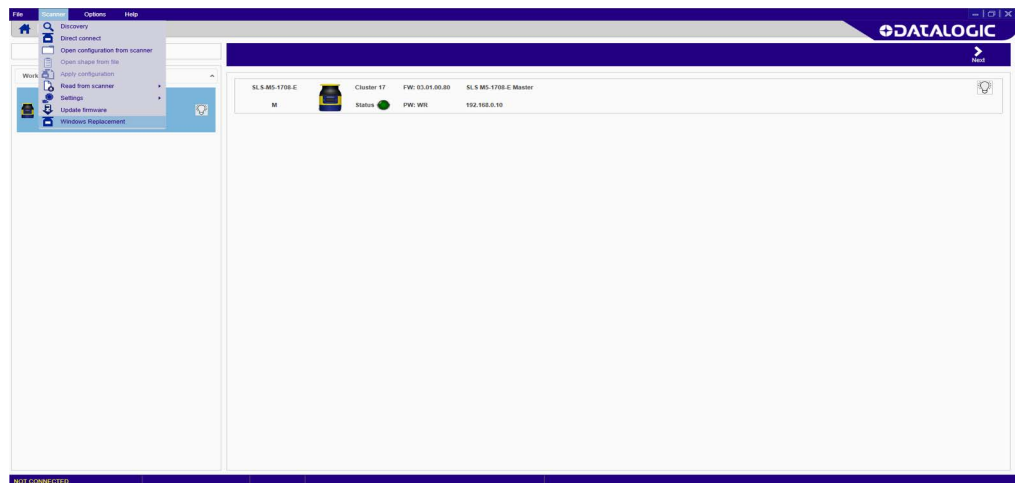

12. Carefully read the disclaimer. By clicking OK you accept the terms and disclaimer contained herein.

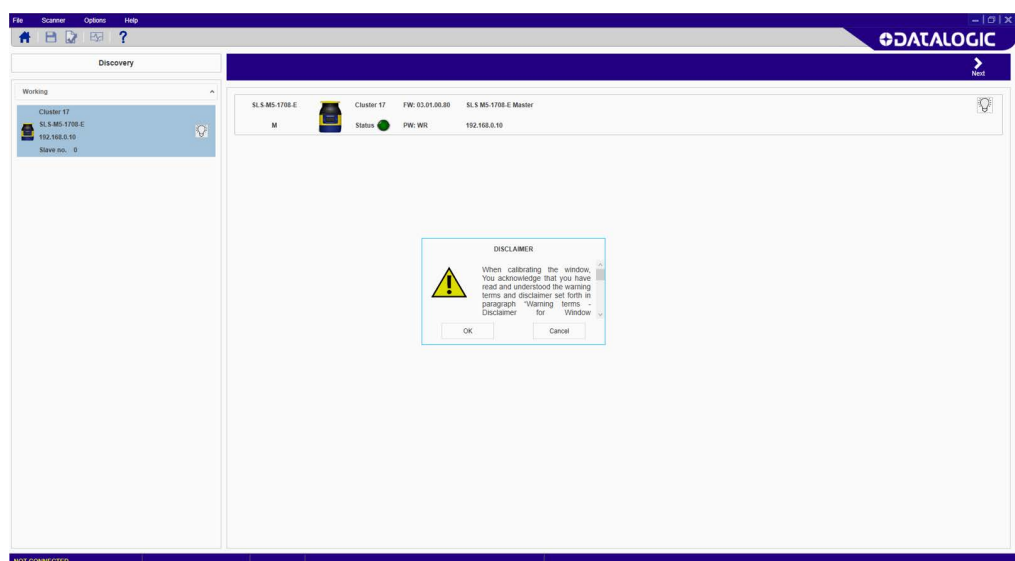

13. Select the device undergoing window replacement and enter the serial number of the new window.

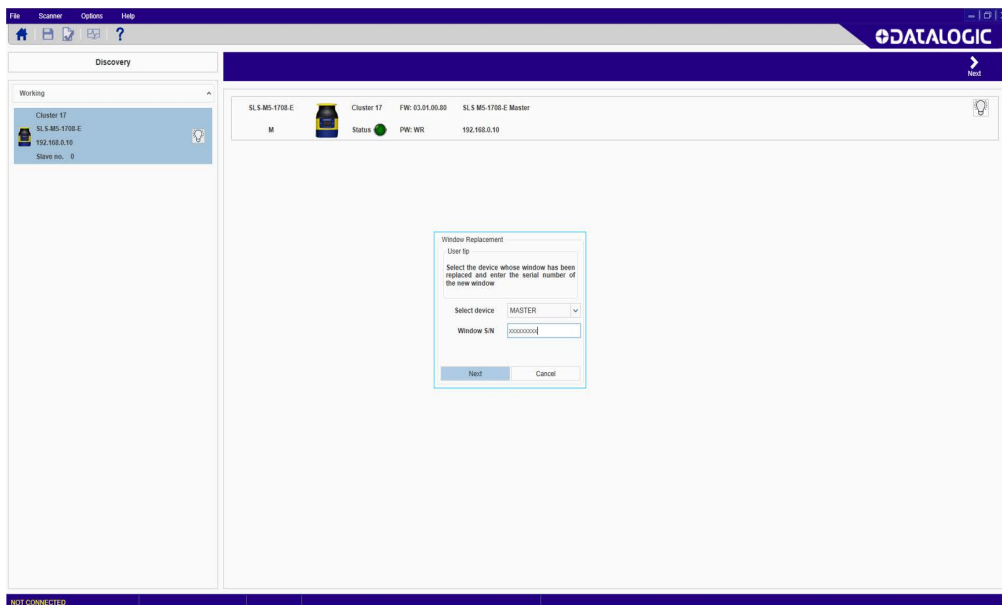

14. Window calibration will start now. Make sure that the device has a 2-meter free area around its 275° angle range.



When window calibration is in progress, the device first switches to offline status (black display), then to offline test mode, displaying the following message.

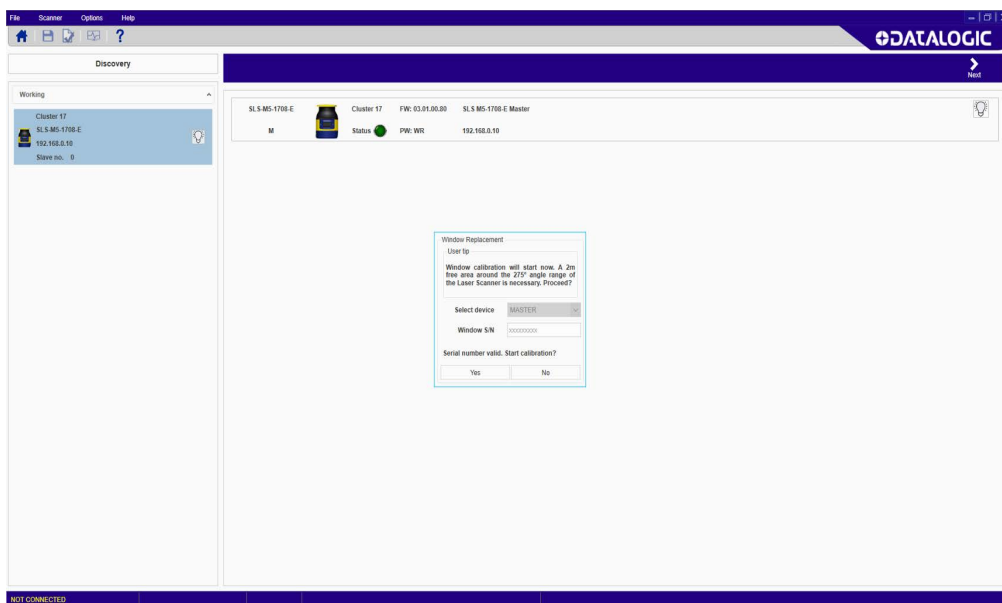

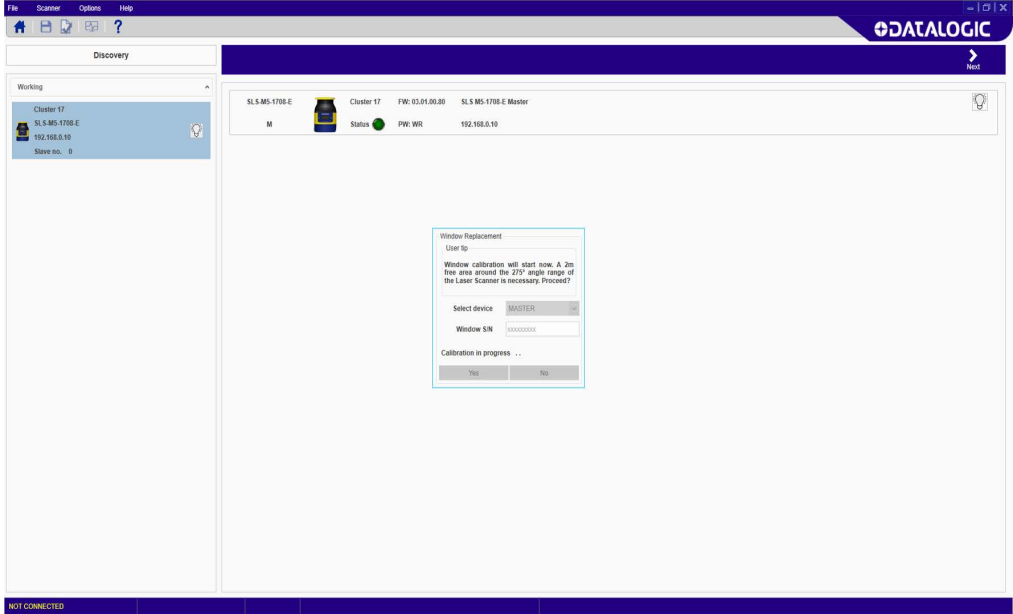

15. If the test area is not compliant, an error message will be displayed. Clear the required area and retry.

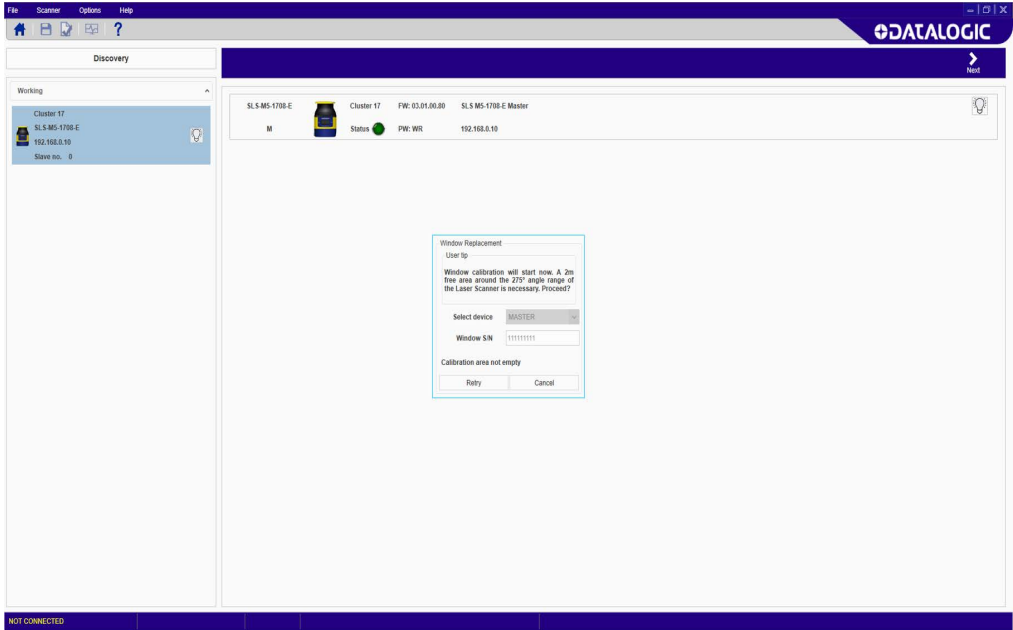

16. To validate the calibration procedure, the user must test the device detection capability with a test configuration.

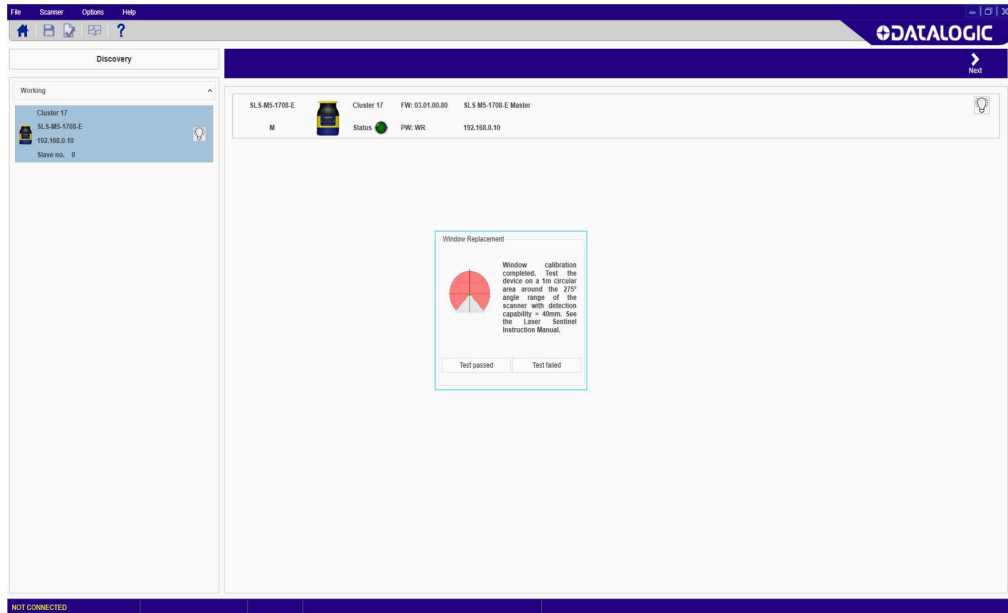

The test area is automatically configured. To test the detection capability of the device(s), use a suitable test piece, e.g. an optically dark, opaque cylinder, with a diameter of 40 mm.

Place the test piece on several points at the edges (distance from the device = 1 meter) of the 275° safety area. The safety laser scanner must detect the test piece at each position and go to STOP. The number and location of sites where the test is performed must be chosen so that undetected access to the hazardous area is not possible.

Do not attempt to insert the test piece into dangerous parts of the machine located in the safety area.

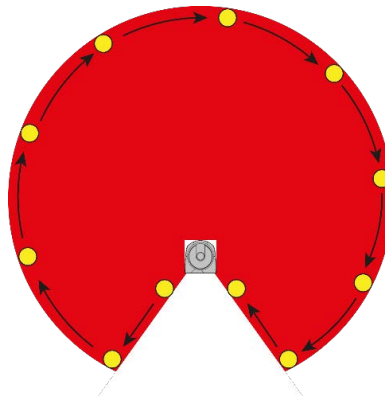

Power off the safety laser scanner(s). Check that both OSSD outputs automatically switch to OFF status and make sure that the machine cannot start until power is re-applied.

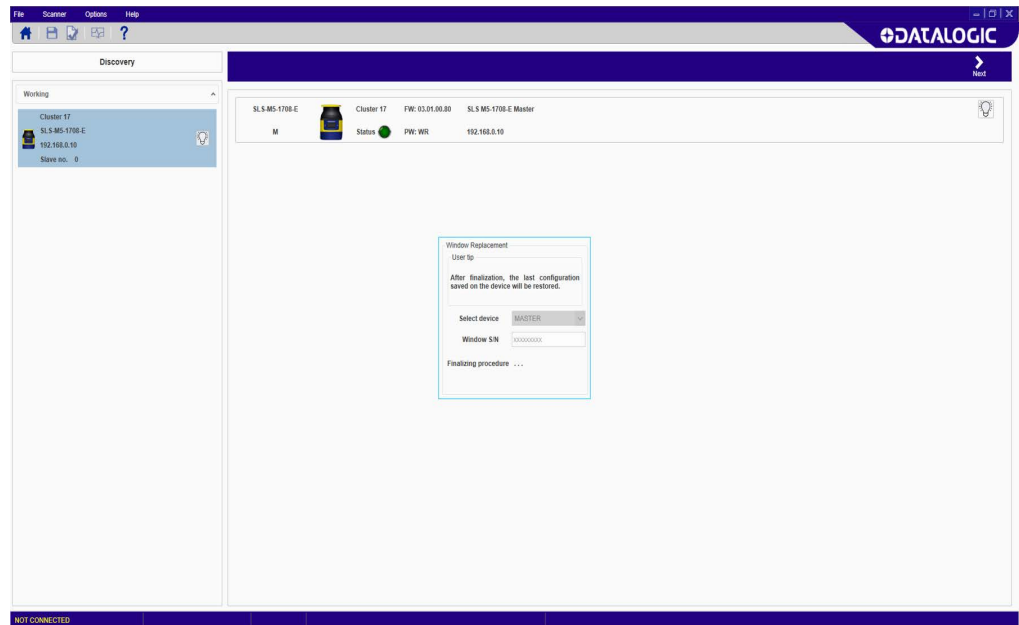

The device remains in test mode until the user validates the test (press “Test assessed”). After validation, the device switches to online mode with the last configuration saved before window replacement¹. If the test is not validated, the device will remain in test mode.



NOTE

If window calibration fails, the Safety Laser Scanner remains in offline mode until power-off and DLSentinel displays the following error message.

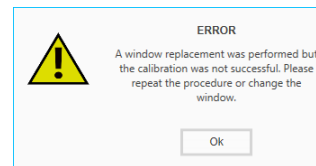

Repeat the procedure described above. Should the calibration fail again, replace the window or contact Datasensing to repair or replace the device.

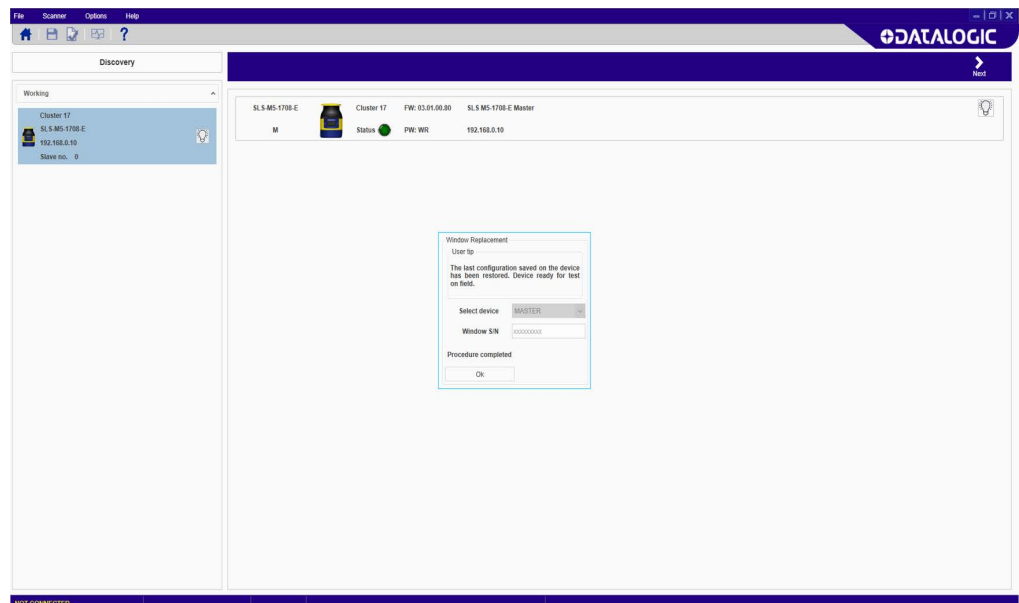

1. If the Window Replacement procedure is performed on a Master device, the last configuration saved on it is preserved. If the procedure is performed on a Slave device, this must be connected to a Master device. In this case, the last configuration is preserved only if the optical window is replaced while the Slave device is connected to the same Master device of said configuration. On the other hand, if the Slave device is connected to a different Master device during Window Replacement, the last configuration will be lost.

- After window calibration has successfully completed, the following fault message is displayed. Click OK.

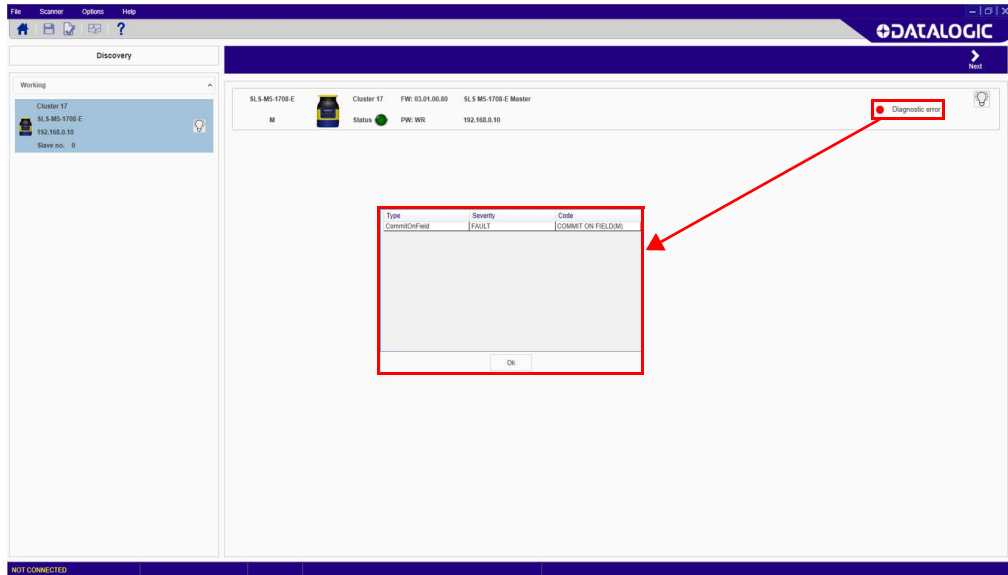

The device display will show the “Commit On Field” warning message.



- Restore the Safety Laser Scanner on field. See [Chapter 4, Installation](#), [Chapter 5, Mechanical Mounting](#), and [Chapter 6, Electrical Connections](#). Perform a field test to commit the configuration (see ["Checks After First Installation" on page 28](#)), then go to *Scanner>Window Replacement* and click “Done” on the displayed message.

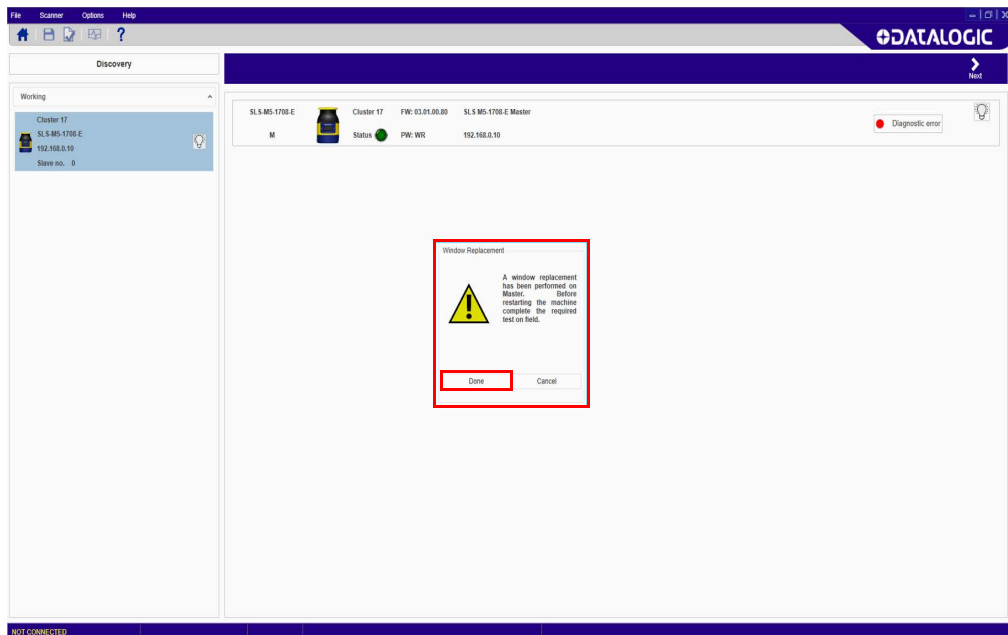

The device will now switch to online mode.

FAST REPLACEMENT

Fast replacement allows the user to quickly replace a Master or Slave device or a Memory Group when these have suffered irreparable damage (see Chapter 9, Diagnostics).



NOTE

Fast Replacement is possible only if the replaced device has the same SW release as the damaged one (e.g. if the damaged Master or Slave device or a Memory Group has SW release 3.Y.Z.xy and the new device has a SW release 3.Y.H.xy, Fast replacement cannot be completed, as the new device must have SW release 3.Y.Z.xy).



NOTE

The user is recommended to contact our Technical Support before performing Fast Replacement to assess the severity of the damage.



WARNING

This procedure must be performed by authorized personnel only.

This procedure can be performed on field to restore normal operation and device configuration if the replacement parts have the exact same part number as the replaced ones.



NOTE

If the replacement parts have a different part number than the replaced ones, a new configuration via DLSentinel graphic user interface is needed.

All instructions are shown on the device display and all tasks can be completed using the keypad, except when the instructions refer to the DLSentinel graphic user interface.



WARNING

At the end of Fast Replacement, the user must confirm the successful completion of the procedure by checking that the safety conditions have been restored and by validating the new part.

The following paragraphs illustrate the procedure for the most common cases of Fast Replacement.

Fast Replacement of the Memory Group

When the Memory Group must be replaced on an already configured Master device, follow the procedure below:

1. disconnect power to the device, unmount the damaged Memory Group and connect the new one (see Chapter 5, Memory Group Unmounting for Cable Connection), then restore power to the device;
2. check Memory Group model compatibility. If the model is not compatible, the device display will show the “MG NO MATCHING” message;
3. the Master device and the Memory Group topologies will not match with each other because the Memory Group has no configuration saved on board. The Master device display will show the “INTF18” error message. This is a normal behavior;
4. the Memory Group can now be aligned with the Master device topology either with a **backup configuration** copied from the Master device to the Memory Group

or with a configuration via DLSentinel. Select the preferred procedure using the keypad.

In case of a backup configuration, follow the procedure shown on the Master device display. For a configuration via DLSentinel, refer to the DLSentinel User's Manual.

Fast Replacement of the Master device

When the Master device must be replaced and the Memory Group is already configured, follow the procedure below:

1. disconnect power to the device, unmount the Memory Group from the damaged Master device and connect it to the new one (see "[Memory Group Unmounting for Cable Connection](#)" on page 38), then restore power to the device;
2. check that the new device has the same part number as the replaced one;



NOTE

If the Master model is not compatible, the display will show the "WAITING CONF" message and a new configuration via the DLSentinel graphic user interface will be required.



NOTE

Only replace the damaged Master device. Do not change any Slave devices or the topology configured before the replacement. Otherwise, the Master device display will show the "WAITING CONF" message and a new configuration via the DLSentinel graphic user interface will be required.

3. the cluster size and models now match and only the serial numbers do not match. The Master device display will show the "CFG NO MATCHING" message. The Master device can now be aligned with the Memory Group topology by **restoring the configuration** from the Memory Group to the device or by creating a new configuration via DLSentinel.
To restore the configuration from the Memory Group, proceed as follows:
 4. after selecting the Restore option, the Master device display will show the "RUN TEST MODE" message;
 5. select "ENTER TEST" to start the test procedure;
 6. at test completion, select "EXIT TEST";
 7. the user is now prompted to **validate** or **reject** the configuration.

Fast Replacement of a Slave device

The Fast Replacement of a Slave device can occur only when a damaged Slave device is replaced with a new Slave device of the same model, and therefore only the serial numbers do not match.

In this case, the new device can be aligned with the Memory Group topology by **restoring the configuration** from the Memory Group to the device. To restore the configuration from the Memory Group:

1. select the Restore option. The Slave device display will show the “CHECK MASTER” message. The Master device display will show the “RUN TEST MODE” message;
2. select “ENTER TEST” using the keypad of the Master device to start the test procedure;
3. at test completion, select “EXIT TEST”;
4. the user is now prompted to **validate** or **reject** the configuration.

Alternatively, a new configuration via DLSentinel can be created (refer to the DLSentinel User’s Manual).



NOTE

When the cluster size or models do not match, a new configuration via DLSentinel must be created (refer to the DLSentinel User’s Manual). This is the case when:

- a new Slave device is added to the current cluster, OR
- a damaged Slave device is replaced with a different Slave model (e.g. a 3-meter model is replaced with a 5-meter model).

FIRMWARE UPDATE

To update the firmware, proceed as follows:

1. Start the DLSentinel GUI and select the new configuration task.
2. Enter the Discovery mode and select an online device.
3. Once the device is selected, click **Scanner** on the menu and choose the firmware update option.
4. Enter the device password (default password “**admin**”, if not changed) to access the firmware update option.

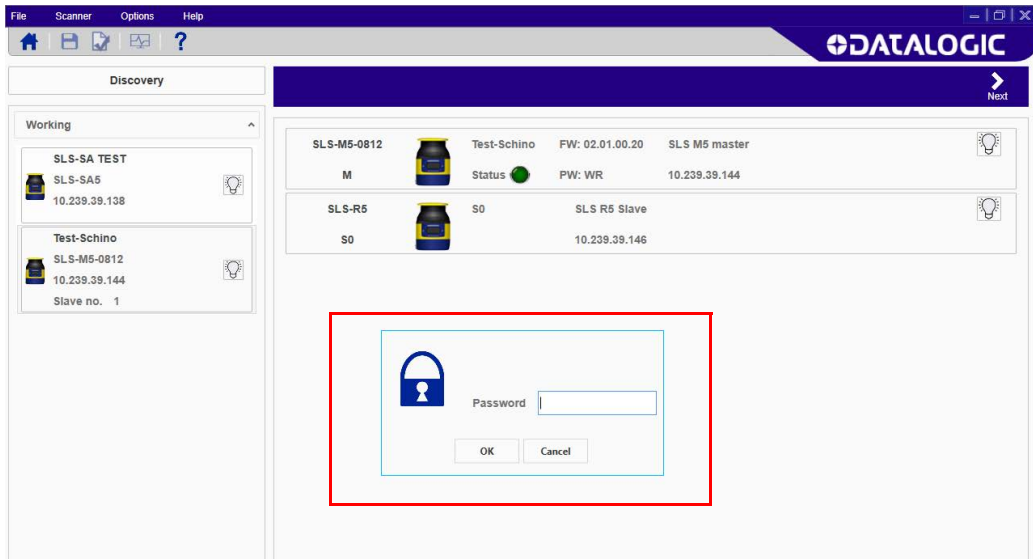

5. In the Firmware update section (**Package section**), click on ZIP Archive to search and select a previously downloaded new firmware version (from the Datasensing website).
6. Once the new firmware version is selected, click on Load (**Configuration Upload**). During the Firmware Update the device will go offline.

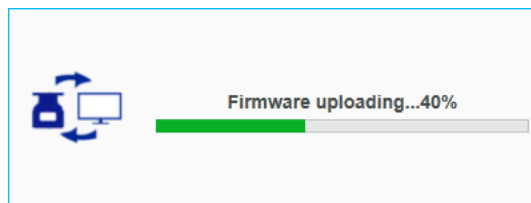

7. When the firmware version is completely loaded, the user enters the Offline-Test mode to create a configuration and test the new firmware version according to the procedure released with the new firmware and validate it on field following the procedure described in "[Checks after Firmware Update](#)" on page 125.
8. If the firmware version is compatible with the device (i.e. the device configuration is correct and with no failures) click on Accept, otherwise click on Reject (**Validation**).

Checks after Firmware Update

As with any configuration change, safety checks are also required after firmware update and device commissioning as well as before normal duty on field. The safety checks must be carried out by qualified personnel in charge of the machine safety or safety maintenance in general.

The minimum checks are listed below:

- To test the detection capability of the device(s), the user can use a suitable test piece, e.g. an optically dark, opaque cylinder. The effective diameter should match the configured resolution. Datasensing suggests adopting the following procedure:

Place the test piece on several points at the edges of the safety area.

Place the test piece on several points inside the area, radially from the edges to the center of the laser scanner.

The safety laser scanner must detect the test piece at each position and go to STOP.

Remove the test piece from the controlled area and check that:

- the machine automatically restarts (in case of Automatic restart), OR
- the machine restarts only after receiving the restart command (in case of Manual restart).

The following pictures are examples of detection capability test (the red areas correspond to the configured Safety Areas).

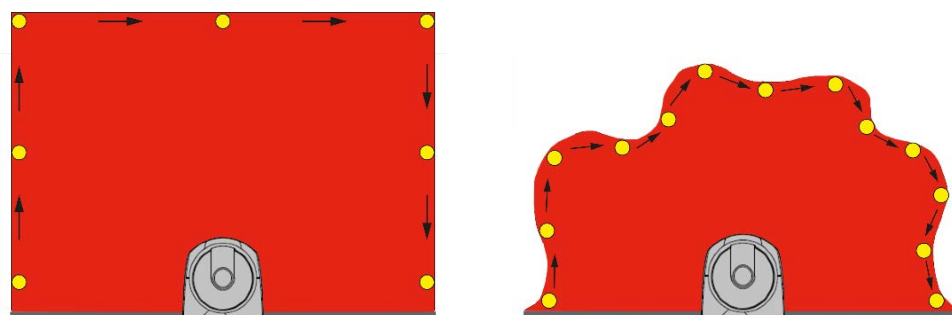

- Power off the safety laser scanner(s). Check that both OSSD outputs automatically switch to OFF status and make sure that the machine cannot start until power is re-applied.
- Together with the mentioned checks, it is recommended to perform a visual check of general functioning using the monitoring tool provided in the Graphic User Interface of the laser scanner.
- Check if the Laser Sentinel shows the interruption of the safety field through the LEDs and/or display.
- It is recommended to follow the same testing approach of detection capability mentioned before also for different safety areas, checking if the device reaction is as expected.
- Evaluate other specific tests to carry out based on the safety risk analysis of your own application.
- If in the end the check reveals a fault or an unexpected behavior, the machine must be shut down immediately. Try to update the software and test the device again following the aforementioned procedure. If the problem persists, contact our Technical Support.

APPENDIX A

TECHNICAL DATA

PHYSICAL CHARACTERISTICS	
Protection class	III (EN 61140 / IEC 61140)
Supply voltage (U _v)	24 Vdc (19.2 V ... 30 Vdc) (SELV/PELV) ^a
Residual ripple	± 5% ^b
Start-up current (I)	< 0.6 A ^c

- a. To meet the requirements of the relevant product standards (e.g. EN 61496-1), the external voltage supply for the devices (SELV) must be able to bridge a brief mains failure of 20 ms. Power supplies according to EN 60204-1 satisfy this requirement.
- b. The absolute voltage level must not drop below the specified minimum voltage.
- c. The load currents for the input capacitors are not taken into account.

CURRENT CONSUMPTION (24VDC)		
	Stand Alone	Master/Slave
No output load (I _{c0})	0.3A @ 24V	0.3A * (No. of Slave devices + 1) @ 24V
With maximum output load (I _{cmax})	I _{c0} + 0.5A @ 24V	I _{c0} + 0.5A * (OSSD No.) @ 24V ^a

- a. OSSD No. = number of OSSD pairs used (or Warning pair outputs)

POWER CONSUMPTION		
	Stand Alone	Master/Slave
Power consumption No output load (P ₀)	8W max. @ 24V	8W * (No. of Slave devices + 1) @ 24V
Power consumption with maximum output load	P ₀ + 12W * (OSSD No.) @ 24V ^a	
Power-up delay	120 s typical ^b	

- a. OSSD No. = number of OSSD pairs used (or Warning pair outputs)
- b. This value depends on models and network Master/Slave configuration.

OSSD (SAFETY OUTPUT)	
OSSD logic and protection	PUSH-PULL, Overcurrent protection
Output voltage for ON status (HIGH)	$\geq U_v - 2V @ 250 \text{ mA}$
Output voltage for OFF status (LOW)	$\leq 0.2V$
Output current for ON status (HIGH)	max. 250 mA
Leakage current	$< 700 \mu\text{A}^a$
Max Load inductance	2 H
Max Load capacity	2.2 μF
Test pulse width	115 μs^b (typical value)
Test period on single OSSDx	900 ms ^b (typical value)
Test pulse shift time between OSSD pairs	150 ms ^b (typical value)
Test pulse shift time between OSSDs	300 ms ^b (typical value)

- a. In the case of a fault (0 V cable open circuit) maximally the leakage current flows in the OSSD cable. The downstream controller must detect this status as LOW. A FPLC (fail-safe programmable logic controller) must be able to identify this status.
- b. Refer to "OSSD test" on page 71

OUTPUT (WARNING AND GENERIC)	
Output logic and protection	PUSH-PULL, Overcurrent protection
Output voltage for ON status (HIGH)	$\geq U_v - 2V @ 250 \text{ mA}$
Output voltage for OFF status (LOW)	$\leq 0.2V$
Output current for ON status (HIGH)	max. 250 mA
Leakage current	$< 700 \mu\text{A}^a$
Max. Load inductance	2 H
Max. Load capacity	2.2 μF

- a. In the case of a fault (0 V cable open circuit) maximally the leakage current flows in the OSSD cable. The downstream controller must detect this status as LOW. A FPLC (fail-safe programmable logic controller) must be able to identify this status.

STATIC INPUT (GENERIC)	
Input voltage (HIGH)	$> 12 \text{ V}$
Input voltage (LOW)	$< 5 \text{ V}$
Input current (HIGH)	2 mA @ 24 Vdc
Input impedance	12 k Ω

MECHANICAL DATA	
Dimensions (W × H × D)	112.5 x 152 x 102
Weight (including system plug)	1.5 kg
Housing material	Aluminum Alloy
Housing color	YellowRAL1003
Optics cover material	PC
Optics cover surface	Acrylic

ENVIRONMENTAL DATA	
Humidity	Max 95% non-condensing According to IEC 61496-1 5.4.2 IEC 61496-3 5.4.2; 4.3.1; 5.4.4.3
Enclosure rating (IP) ^a	IP65
Operating temperature ^b	-10 to +50 °C
Storage temperature	-20 to +70 °C
Vibration resistance	According to IEC 61496-1 (4.3.3.1;4.3.3.2;5.4.4.1): Class 3M7 (Stationary Use) Class 5M2 (Ground Vehicle Installation, sinusoidal/broadband vibration)
Shock resistance	According to IEC 61496-1 (4.3.3.1;4.3.3.3;5.4.4.2): Class 3M7 (Stationary Use) Class 5M2 (Ground Vehicle Installation) IEC 61496-3 (5.4.4),IEC 60068-2-75 (Hammer Test)

- a. The enclosure rating is valid if all the safety laser scanner M12 connectors are sealed using an IP65 rated connection cable or higher or if not connected by using a protective cap.
- b. It is recommended to allow for a 15-minute warm-up from a cold start at a temperature < 5 °C before using the device in normal operation.

OPTICAL DATA	
Wavelength	905 nm
Pulse duration	3 ns
Average output power	8 mw
Laser class/Laserklass	CLASS 1 (EN 60825-1:2014)
Divergence of collimated beam	0.12 °

FEATURES		
	5.5 m Models	3 m Models
Safety protective zone range	0.05 ... 5.5 m for 70/150 mm of detection capability	0.05 ... 3 m for 40/50/70/150 mm of detection capability
	0.05 ... 4 m for 50 mm of detection capability	
	0.05 ... 3 m for 40 mm of detection capability	0.05 ... 2.5 m for 30 mm of detection capability
	0.05 ... 2.5 m for 30 mm of detection capability	
Warning zone range	0.05 ... 40 m	
Max. detection range	0.05 ... 50 m (typical) for flat reflecting target (1000%)	
	0.05 ... 40 m (typical) for flat white 90% target	
	0.05 ... 22 m (typical) for flat gray 18% target	
	0.05 ... 8 m (typical) for flat black 1.8% target	
Max. number of simultaneous warning areas	2	
Scanning angle	275 °	
Detection capability	30/ 40 / 50/ 70 / 150 mm selectable	
Scan cycle time	30 ms min. (see "Anti-Interference Coding" on page 88)	
Response time	Programmable 62 - 1292 ms	
Network latency time (Master Slave model)	10 ms for each connected Slave device 1 Master + 1 Slave device → 62 (.1202) ms + 10 ms = 72 (.1212) ms 1 Master + 2 Slave devices → 62 (.1202) ms + 20 ms = 82 (.1222) ms 1 Master + 3 Slave devices → 62 (.1202) ms + 30 ms = 92 (.1232) ms	
Max. tolerance zone	100 mm	
Angular resolution	0.1 °	
Zone sets	Stand Alone: max. 6 8-pole Master: max. 3 12-pole Master: max. 10 17-pole Master: max. 20 17+8 pole Master: max. 70	
Wait time for next zone switching request after input delay expiration of previous one	60 ms	
Supplement for retro-reflectors on scan plane in front of a safety zone	200 mm (refer to "High Reflecting Background" on page 13)	
Supplement for high ambient light within ±5° of the scan plane.	200 mm (refer to "Light Interference" on page 12)	
Deviation from ideal flatness of scan field at max safety range m	< 5 cm	
Distance of mirror rotational axis (zero point of x and y axis) to rear side of device	52.5 mm	

Distance between center point of scan plane and top edge of the housing	37.7 mm
Applications	Horizontal, Moving, Vertical

LIGHT BEAM DIAMETER

At front screen	8 mm
At middle field distance	10 mm
At max distance	20 mm
Detectable remission	1.8% - "1000%"
Maximum homogeneous contamination of the optics cover without preventing the detection capability	- 30% of nominal optic power

SAFETY DATA

Type	Type 3 (EN 61496-1)
Safety integrity level	SIL 2 (IEC 61508)
Category	Category 3 (EN ISO 13849-1)
Maximum SIL	SIL 2 (EN 62061)
Performance level	PL d (EN ISO 13849-1)
PFHd (mean probability of a dangerous failure per hour)	6.38×10^{-8}
SFF	97.58 %
MTTFd	61 Years
TM (mission time)	20 years (EN ISO 13849-1)
HFT (Hardware Fault Tolerance)	1
State of safety	OSSD in OFF State (open circuit: I OSSD = 0)
Response time to malfunction	<= Response Time

CONNECTORS

I/O and power	M12 male type A connector (8/12/17 poles)
Ethernet to GUI or Data transmission	M12 male type D connector (4 poles)
Master to Slave Slave to Slave	M12 male type A connector (8 poles)

ENCODERS

Encoder type	Incremental encoders with A and B outputs
Input max. frequency	100 kHz

APPENDIX B

OVERALL DIMENSIONS

LASER SENTINEL STAND ALONE MODEL

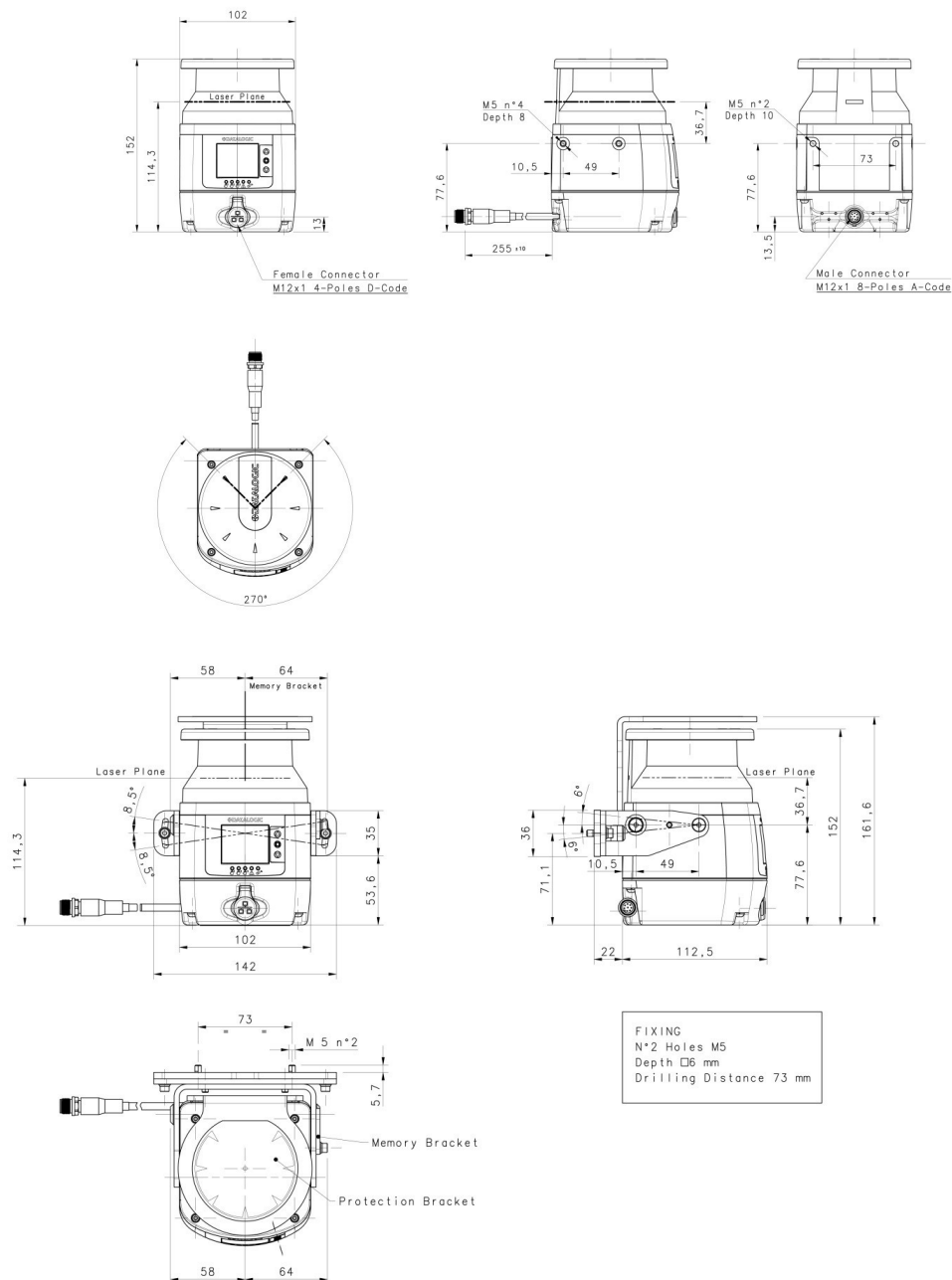

LASER SENTINEL MASTER MODEL

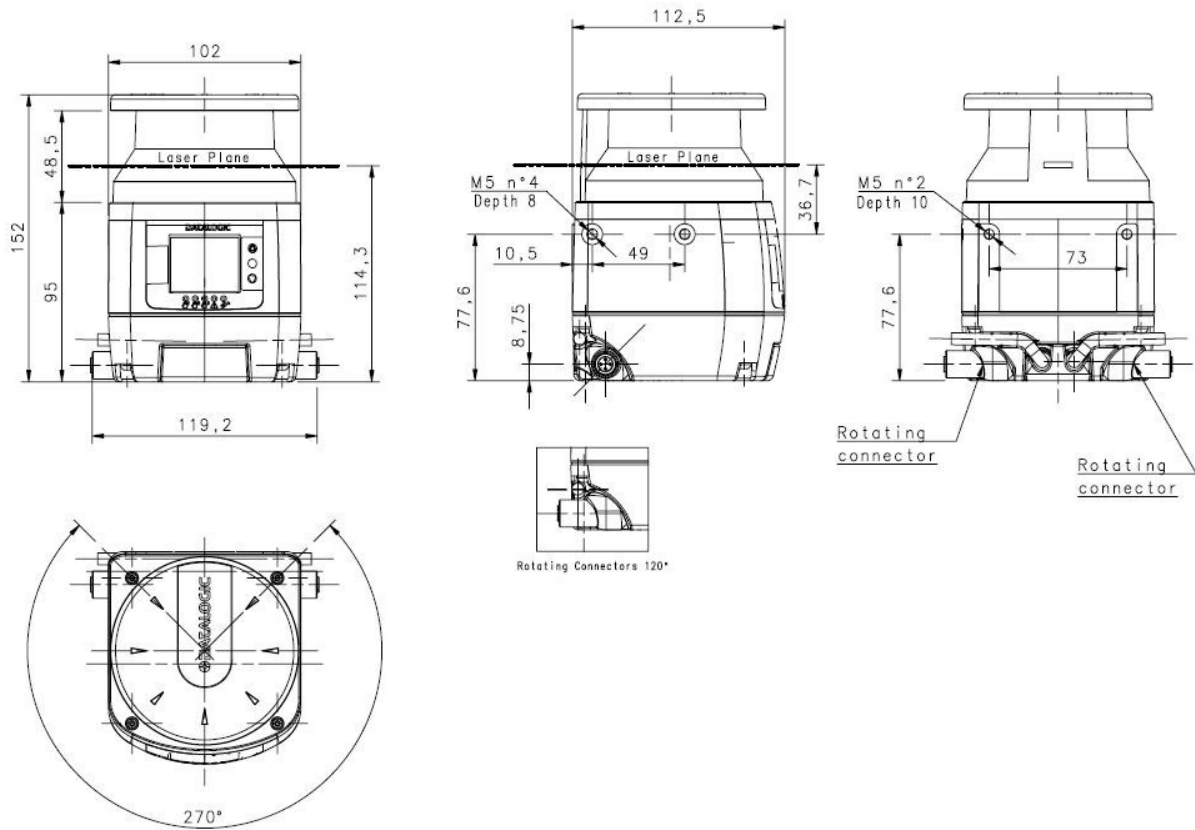

LASER SENTINEL SLAVE MODEL

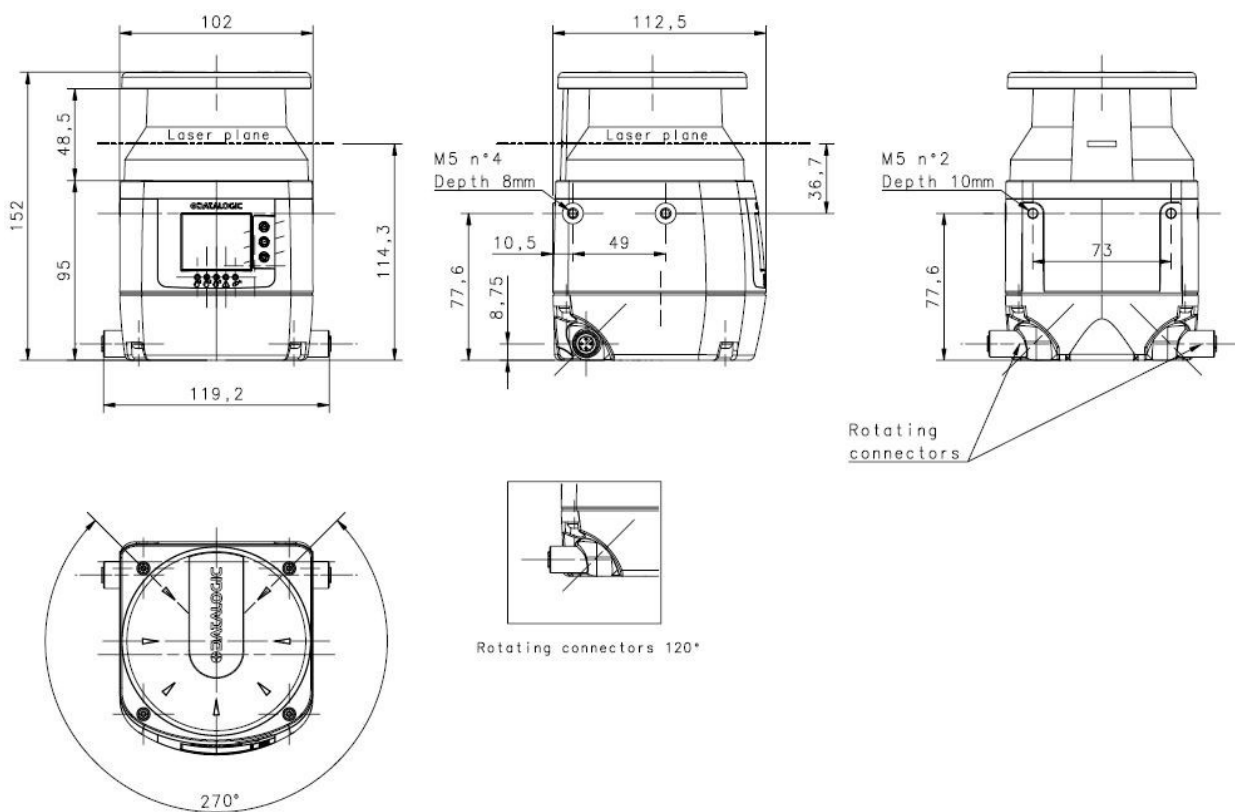

APPENDIX C

ACCESSORIES

MOUNTING BRACKETS

MODEL	DESCRIPTION	CODE
SLS-BRACKET-A	Complete bracket system	95ASE2920
SLS-BRACKET-B	Pitch regulation bracket system	95ASE2930
SLS-BRACKET-C	Head protective bracket	95ASE2940

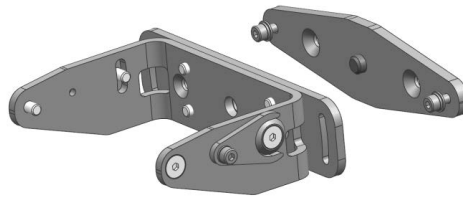

Figure 1 - Kit A



Figure 2 - Kit B

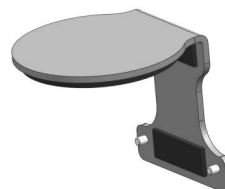

Figure 3 - Kit C

ETHERNET CABLES

MODEL	DESCRIPTION	CODE
CAB-ETH-M01 M12-IP67 ETHERNET CAB. (1M)	Ethernet cable to Host 1 m	93A051346
CAB-ETH-M03 M12-IP67 ETHERNET CAB. (3M)	Ethernet cable to Host 3 m	93A051347
CAB-ETH-M05 M12-IP67 ETHERNET CAB. (5M)	Ethernet cable to Host 5 m	93A051348
CAB-ETH-M10 M12-IP67 ETHERNET CAB. (10M)	Ethernet cable to Host 10 m	93A051391
SLS-CABLE-R-10 ETHERNET CBL TO REMOTE (10M)	Ethernet cable to Remote 10 m	95ASE2900
SLS-CABLE-R-20 ETHERNET CBL TO REMOTE (20M)	Ethernet cable to Remote 20 m	95ASE2910
SLS-CABLE-R-5 ETHERNET CBL TO REMOTE (5M)	Ethernet cable to Remote 5 m	95ASE2890

ELECTRICAL CABLES

MODEL	DESCRIPTION	CODE
CS-A1-06-U-03	CS Cable axial M12F 8-pin to free wires 3m no shield	95ASE1220
CS-A1-06-U-05	CS Cable axial M12F 8-pin to free wires 5m no shield	95ASE1230
CS-A1-06-U-10	CS Cable axial M12F 8-pin to free wires 10m no shield	95ASE1240
CS-A1-06-U-15	CS Cable axial M12F 8-pin to free wires 15m no shield	95ASE1250
CS-A1-06-U-25	CS Cable axial M12F 8-pin to free wires 25m no shield	95ASE1260
CS-A1-10-U-03	CS Cable axial M12F 12-pin to free wires 3m no shield	95A252720
CS-A1-10-U-05	CS Cable axial M12F 12-pin to free wires 5m no shield	95A252730
CS-A1-10-U-10	CS Cable axial M12F 12-pin to free wires 10m no shield	95A252740
CS-A1-10-U-15	CS Cable axial M12F 12-pin to free wires 15m no shield	95A252750
CS-A1-10-U-25	CS Cable axial M12F 12-pin to free wires 25m no shield	95A252760
CS-A1-15-U-03	CS Cable axial M12F 17-pin to free wires 3m no shield	95ASE3010
CS-A1-15-U-05	CS Cable axial M12F 17-pin to free wires 5m no shield	95ASE3020
CS-A1-15-U-10	CS Cable axial M12F 17-pin to free wires 10m no shield	95ASE3030
CS-A1-15-U-15	CS Cable axial M12F 17-pin to free wires 15m no shield	95ASE3040
CS-A1-15-U-25	CS Cable axial M12F 17-pin to free wires 25m no shield	95ASE3050



NOTE

User supplied cables must abide by the safety regulations for color-coding and have a maximum length of 50 m.

SAFETY UNITS

MODEL	DESCRIPTION	CODE
SE-SR2	Safety Unit	95ACC6170
CSME-03VU24-Y14	Forcibly guided relay interface	95ASE1270



NOTE

The CSME interface requires the activation and correct wiring of an EDM signal on the Safety Laser Scanner.

MAINTENANCE ACCESSORIES

MODEL	DESCRIPTION	CODE
SLS-WINDOW	Replacement window	95ASE2971
SLS-MG-0812	Memory group M12 8/12 pins	95ASE2960
SLS-MG-1708	Memory group M12 17/8 pins	95ASE2950
SLS-CLEANER	Cleaning agent	95ASE2990
SLS-CLOTH	Cleaning cloth	95ASE3000

APPENDIX D

GLOSSARY

NAME	DESCRIPTION
Active opto-electronic protective device responsive to diffuse reflection (AOPDDR)	A device whose sensing function is performed by optoelectronic emitting and receiving elements. These detect the diffuse reflection of optical radiations generated within the device by an object located in a detection zone (specified in two dimensions).
Application Type	<p>The configuration's classification according to the visibility of the parameters. It can be:</p> <ul style="list-style-type: none"> • Expert - it contains the whole set of parameters, regardless of the device use. • Vertical - it requires the user to insert the reference points parameter. <p>Default values are provided for all interface parameters.</p>
Demo Configuration	A configuration's classification according to the visibility of the parameters. Demo Configuration is made only for demonstration purposes and the User has to insert only a Safety Area and a Warning Area.
Catalogue	A list of all the available models of safety laser scanner and the start point for an Offline configuration. User will use a configuration wizard in the Offline mode.
Coding	The combination of Area Switch input codes to determine zone sets. The input code must respect the hamming distance.
Configuration	<p>The whole set of parameters that determine the device behavior. It can be classified according to the visibility of the configuration parameter:</p> <ul style="list-style-type: none"> • Horizontal • Vertical <p>The device configuration contains the whole set of parameters. If the User is not able to set them, the interface will provide default values.</p> <p>By showing devices positioning, the classification based on topology helps the User draw a Safety or a Warning Zone.</p>
Configuration Validator	<p>A feature used in DLSentinel to verify complete configuration correctness.</p> <p>Specific Warnings will display incorrect configuration parameters.</p>
Detection Capability	The minimum size of a detectable object by a device. This parameter can be set for a Safety Zone and a Warning Zone of each Area.

NAME	DESCRIPTION
Device	The Laser Sentinel safety laser scanner.
Download	This is an operation that transfers the configuration from a Device to the GUI.
Dust Filtering	<p>The Dust Filter Level must be set according to different conditions specific to the application. In general, it is the sensibility to various levels of airborne particles that impact the response of the Laser Sentinel detection.</p> <p>A High Dust Filter Level is used in dirty environments to filter (ignore) detection of airborne particles from being confused with objects to detect. The Laser Sentinel is less sensitive to dust and therefore avoids shutting down the machinery unnecessarily.</p> <p>A Low Dust Filter Level is used in cleaner environments where airborne particles have little effect on object detection.</p> <p>Dust Filter Level should be set to the lowest value that still allows the machinery to work without detections due to dust.</p>
Expert Configuration	A configuration's classification according to the visibility of the parameters. This one allows the User to change the whole set of parameters (regardless of the device use).
Failure	Termination of the ability of an item to perform a required function.
Fault	State of an item characterized by its inability to perform a required function, excluding the inability during preventive maintenance or other planned actions, or due to lack of external resources.
GUI	<p>The DLSentinel Graphic User Interface. It can be used to:</p> <ul style="list-style-type: none"> • Create a configuration • Read a configuration • Write a configuration • Upload a configuration • Download a configuration • Open Report • Read Log • Monitoring (receive data)
Hazardous / Dangerous zone	Any space within and/or around machinery in which a person can be exposed to a hazard.
Height	Device height: the distance between the floor and nominal scan plane at the scanner output window.
Input Configuration	It is the name of the DLSentinel configuration panel that contains the parameters to assign to the input pins (i.e. Restart).
Lock-out condition	Condition, initiated by a fault, preventing normal operation of the protective equipment. When all output signal switching devices (OSSDs) and, where applicable, all final switching devices (FSDs) are signaled to go to the OFF-state.
Minimum distance (S)	Calculated distance between the safeguard and the hazard zone necessary to prevent a person or part of a person reaching the hazard zone before the termination of the hazardous machine function.

NAME	DESCRIPTION
Monitoring	<p>The GUI obtains data from a device and shows the following information:</p> <ul style="list-style-type: none"> • OSSDs state (Open/Close) • Inputs state (ON/OFF) • Auxiliary Outputs State (ON/OFF) <p>The User can save a static image of a monitoring case and use it in Simulation.</p>
Network	<p>It contains all the devices connected to the network and it is the starting point for online configuration. The User will employ a configuration wizard for an offline configuration instead.</p>
Number of Scans	<p>When an object is detected in the Safety Zone, the device scans the area a certain number of times before going to OFF status. This number depends on the parameter set in the configuration.</p>
OFF-state	<p>State in which the output circuit is interrupted and does not permit the flow of current. When Laser Sentinel detects an object in the safety zone it switches to this state which causes the dangerous machinery to stop working.</p>
ON-state	<p>State in which the output circuit is complete and permits the flow of current. This is the normal operating state in which the Laser Sentinel is controlling the safety area and the dangerous machinery is operating.</p>
Output signal switching device (OSSD)	<p>Component of the electro-sensitive protective equipment (ESPE) connected to the machine control system. If an object is detected in the Safety Zone, the safety couple of outputs turns off (OFF-state).</p>
Override	<p>The Override feature is possible when the Laser Sentinel is in the SAFE state (detection in the Safety Zone) and allows the user to force the OSSDs to ON state whenever it is necessary to restart the machine.</p>
Programming	<p>A configuration step that allows downloading a configuration. The User can accept or reject the safety configuration report and eventually save or print it.</p>
Recovery Time	<p>The Recovery Time is the time between the object removal from the protected area and the OSSDs achieving the NORMAL OPERATION.</p>
Report	<p>Configuration is the whole set of parameters that defines the behavior of the device. A Report is the document that shows configuration's parameters to the user.</p>
Response Time	<p>Maximum time between the occurrence of the event leading to the actuation of the sensing device and the output signal switching device (OSSD) achieving the OFF-state.</p>
Restart Interlock	<p>Means of preventing automatic restart of the machine after actuation of the sensing device during a hazardous part of the machine operating cycle (after a change in mode of operation of the machine, and/or after a change in the means of start control of the machine).</p>
Safety System Log	<p>It shows the Log file.</p>
Safety Zone	<p>It is an area assigned to an OSSD couple in which the OSSDs turn OFF if an object is detected. For example:</p> <ul style="list-style-type: none"> • Zone 1 -> OSSDs 1/1 1/2; <p>Each zone may have a different behavior. The User can set: Start/Restart, Detection Capability, Input code, Safety and Warning Zone.</p>

NAME	DESCRIPTION
Teach-in	<p>A feature that scans the configuration in order to process and use the results for:</p> <ul style="list-style-type: none"> • Dust settings - to choose the best Dust Immunity level according to device's environment. • Zone Configurator - to draw automatically Warning or Safety Zone. <p>Note: This feature is available only in the Online mode.</p>
Upload	<p>An operation to transfer the configuration from the GUI to the Device.</p>
Warning Zone	<p>This is the area around the Safety Zone; the device can signal a warning lamp or siren if it detects an object in this area.</p>
Zone Set	<p>This is an area (zone) that is controlled by the Laser Sentinel. More than one zone can be defined and therefore switched (set) by a combination of inputs.</p>

© 2018-2023 Datasensing S.r.l. • All rights reserved • Without limiting the rights under copyright, no part of this documentation may be reproduced, stored in or introduced into a retrieval system, or transmitted in any form or by any means, or for any purpose, without the express written permission of Datasensing S.r.l. • Datasensing and the Datasensing logo are trademarks of Datasensing S.r.l. • Datalogic and the Datalogic logo are registered trademarks of Datalogic S.p.A. in many countries, including the U.S. and the E.U.



Datasensing S.r.l.

Strada S. Caterina 235 | 41122 Modena | Italy
Tel. +39 059 420411 | Fax +39 059 253973