

Press [MODE] button to for the advanced settings

ELECTRICAL DIAGRAM OF THE CONNECTIONS

PNP Output

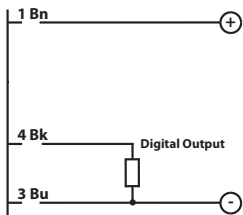

NPN Output

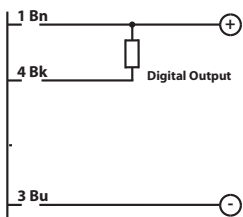

DIMENSIONS

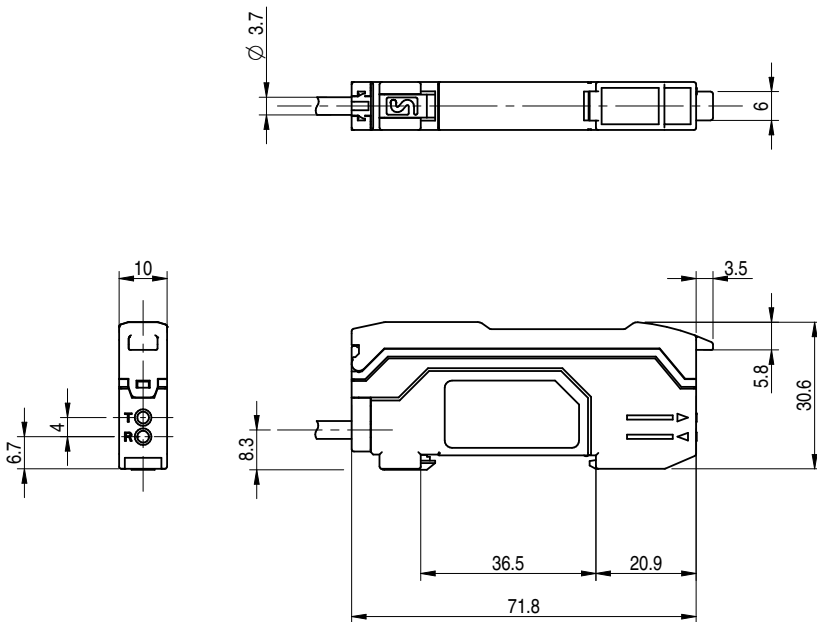

PLUGS

M8 4 PIN

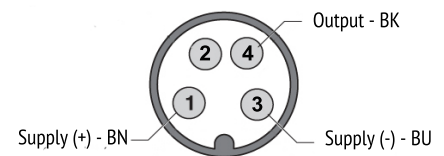

	FY2/0*-0*	FY3/0*-0*
Sensing distance	See optical fiber table	
Emission	Red (680nm)	
Operating Voltage	12...24Vdc	
Ripple	10%	
No-load supply voltage	≤ 50mA	≤ 40mA
Maximum load current	≤ 100mA	
Out voltage Vdrop	≤ 1,5V	≤ 1 V
Output type	NPN or PNP (Lon/Don)	
Response time	40µs (HIGH SPEED) 250 µs (FINE) 1ms (SUPER) 16ms (MEGA)	OFF: 100µs (HIGH SPEED) 250 µs (FINE) 1ms (SUPER) 8ms (MEGA) ON: 300µs (HIGH SPEED) 500 µs (FINE) 2ms (SUPER) 16ms (MEGA) Anti-mutual Int 2ms
Leakage current	≤ 10µA	≤ 10µA
Anti mutual interference function	No	Si Yes
Power supply protection	Polarity inversal	
Output protection	Overcurrent Overvoltage	
Timer function	Delay ON Delay OFF ONE SHOT	
Operative temperature	-20°C...+55°C (without freeze)	
EMC	In conformity with EMC (according to EN 60947-5-2)	
Interference light	Incandescence lamp 20Klux, Sunlight 30Klux	
Humidity	35...85%	
Protection degree	IP64	
Housing Material	PC	
Dimension	71,8 x 30,3 x 9,80 mm	
Connection	Cable 2m Pig-tail 150mm conn. M8 4pin	
Weight	50g (cable), 80g (pig-tail M8)	



MODULE INSTALLATION

DIN Track installation

Align the slot at the bottom of the device with the DIN track, as shown in Figure 1. Push the device to the direction of arrow 1 and press down in the direction of arrow 2.

To remove the sensor, push the device forward to the arrow 1 meanwhile raise the device to the arrow 3 direction.

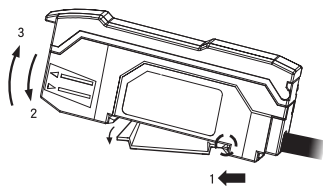

Figure 1

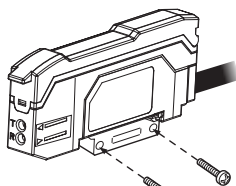
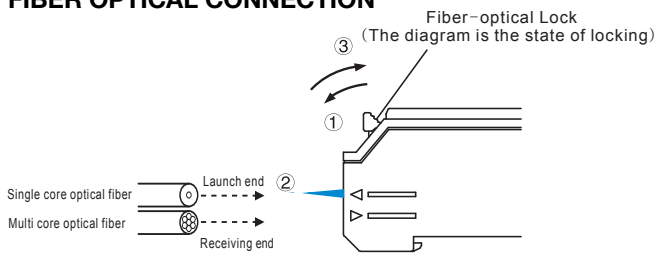

Figure 2

FIBER OPTICAL CONNECTION



- ① Lock rod to horizontal position
- ② Insert the optical fiber until to the most inside
- ③ Dial the lock lever to the vertical position, at this point the optical fiber has been fastened, remove the optical fiber and dial the lock lever to the horizontal position

To connect coaxial reflector optical fiber unit to amplifier, please connect the single core optical fiber to the launch end, and multi core optical fiber to the receiving end.

STANDARD CALIBRATION MODE

One points calibration
One points calibration is the most basic calibration mode.
Just press two times [SET] button to calibrate the sensitivity.
Press once when placed and not.

Opposite-type setting mode

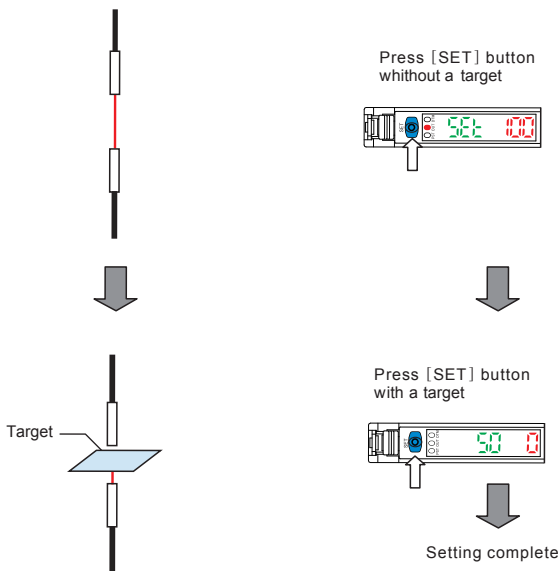

Reflection type

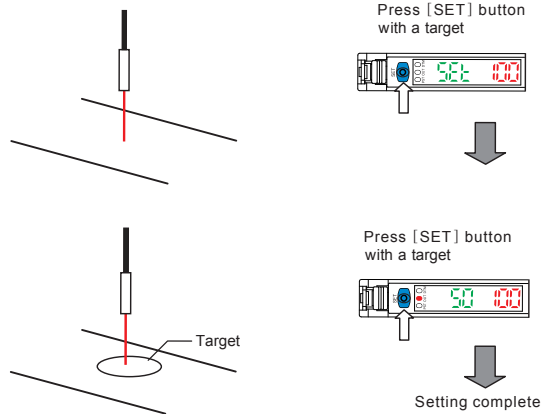

Two point calibration is based on with the target or without the target to calibrate. The preset point is the intermediate value of the above two cases. If the difference between the cases that with or without target is too small, then after the calibration will appear "----" blink for about 2 seconds.

HIGH POWER CALIBRATION MODE

Enhance the applicability in a dusty ambient

- Maximum sensitivity setting

In the case shown below, hold down the [SET] button for 3 seconds or longer, until "SEt" blinking

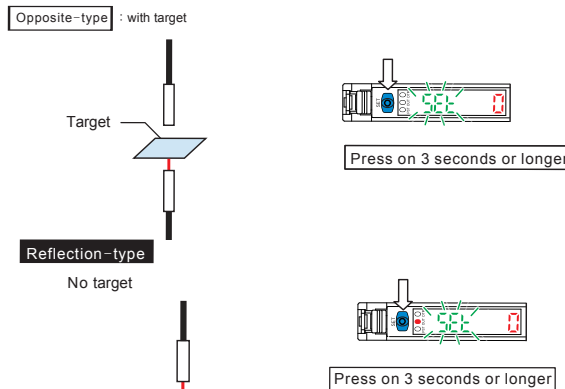

Calibrating the moving workpiece

- Automatic calibration
With a target press [SET] button, when "SEt" is blinking, make the workpiece pass through the sensing area.
(don't release the [SET] button when the target is passing through the sensing area)

Opposite-type and Reflection-type are the same

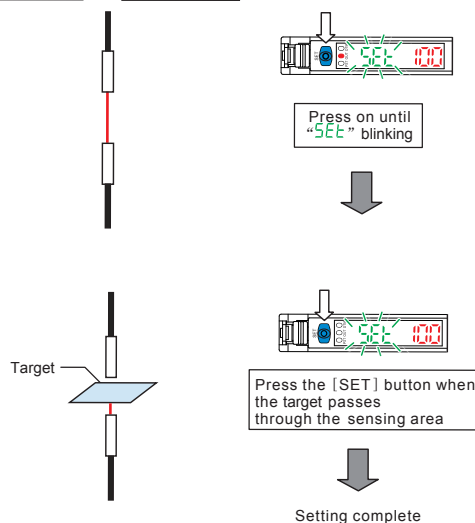

Micro Detectors
Italian Sensors Technology



WARNING These products are NOT safety sensors and are NOT suitable for use in personnel safety application

Declaration of conformity
M.D. Micro Detectors S.p.A. con Unico Socio declare under our sole responsibility that these products are in conformity with the following EMC directive.

Fine calibration

Positioning calibration

In the case of NO workpiece, press [SET] button.
Place the target in the desired position, press the [SET] button for 3 seconds or longer, until "SEt" blinking, release the button.
When the target is placed, the edge of the workpiece is aligned with the center of the beam.

Opposite-type and Reflection-type are the same

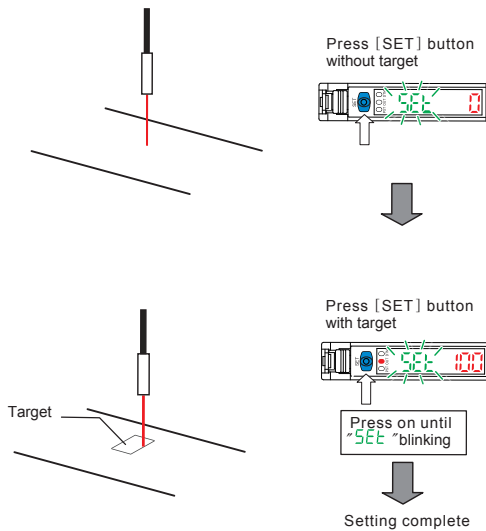

Pre-setting function

When the light is received, press the preset button, and the current value is set to be "1000"

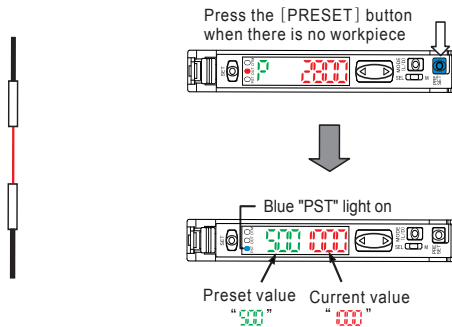

Press the [PRESET] button to change the preset value and the current value.

When disable the presetting function
The preset value is set to "500", the preset value can be changed by normal calibration.

When the presetting function is enable, the current value is setting to "1000", the preset value is unchanged.

Notice The preset function can not be used together with the zero point migration function. If you want to use the zero point migration function, you must disable the preset function first. This mode is not suitable to transparent workpiece and other low light intensity difference detection cases.

Disable the presetting function

Press the [PRESET] button to disable the presetting function. When the presetting function is disable, the ratio between the preset value and the current value is unchange.



Tips

The convenience of presetting functions. This function can be used to reduce the signal emitted in the barrier configuration or to detect opaque objects with shiny backgrounds in direct diffusion mode.

Set the current value to be "0"

Zero point migration function

This function is mainly used for reflection type. Press the [PRESET] button and press the [▶] button together. Set the current value to be "0"

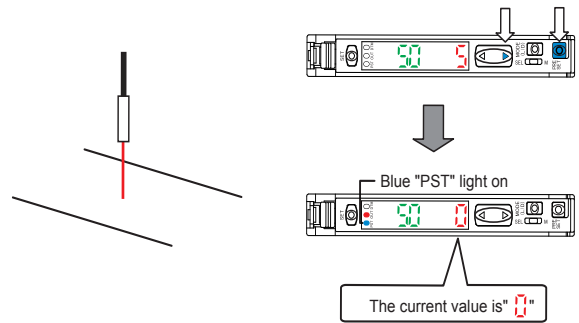

Notice

The preset function can not be used together with the zero point migration function. If you want to use the zero point migration function, you must disable the preset function first.

- Disable the zero point migration function
Press [PRESET] button to disable the zero point migration function



Tips

The convenience of zero point migration function
This function is mainly used to set the current value to "0" for reflective fiber optical unit.
Sometimes after installing the reflective fiber optical unit, the intensity of light is not be set to "0"
If this happens, use zero migration function to set the value to "0" when no workpiece. This makes the light intensity difference more obvious

Adjusting when the light intensity is too large (saturated)

Enable the saturation recovery function

Press the [MODE] button and the [SET] button together, to enable saturation recovery function.

Optical transmission level and light intensity gain will be automatically calibrated at this time.

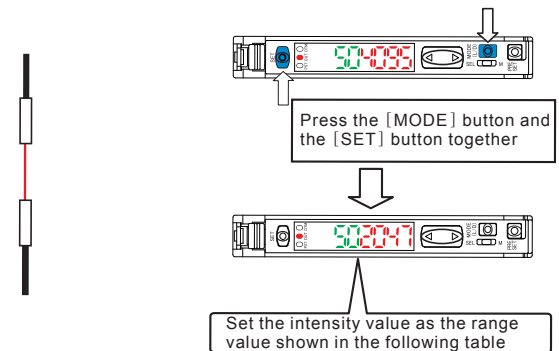

Power mode	Light intensity setting range
HSP*, FINE	2000 ± 350
SUPER	4095 ± 500
MEGA	5000 ± 600

*HIGH SPEED

Disable the saturation recovery function

When the saturation recovery function is enable, press the [MODE] button and the [SET] button together to disable this function.



Tips

The convenience of the saturation recovery function
After installation, this function is particularly useful when the light value intensity is saturated. This function can automatically calibrate optical transmission level and optical gain through simple operation



Micro Detectors
Italian Sensors Technology



WARNING These products are NOT safety sensors and are NOT suitable for use in personnel safety application

Declaration of conformity

M.D. Micro Detectors S.p.A. con Unico Socio declare under our sole responsibility that these products are in conformity with the following EMC directive.

DATUM MODE

The DATUM mode opposite-type is suitable for the light intensity is gradually changing ambient. Such as that large scale temperature changes or easily pollute the optical module ambient .

The DATUM mode's reflection type is only suitable for the ambient with a strong reflection background and a weak target. For example, a black button on a white cloth.

In the DATUM mode, the intensity of the received light is always corrected to " 600 " for DATUM1) , " 800 " (for DATUM2) when without target.

In addition, the preset value will be corrected according to the correction amount, then the ratio between the preset value and the received light intensity remains unchanged.

Start the operation of the DATUM mode.

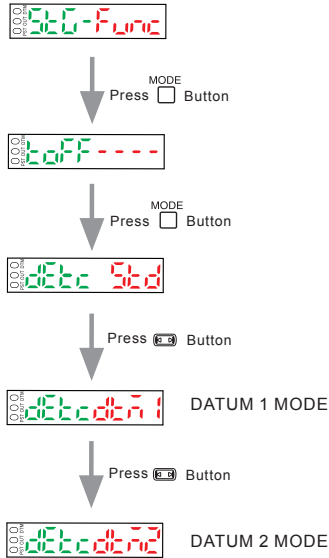

Sensitivity setting in DATUM mode 1 - Detection shiny object

The sensitivity pre set value is always automatically corrected, therefore, in case of no target, the intensity of light received is " 600 "

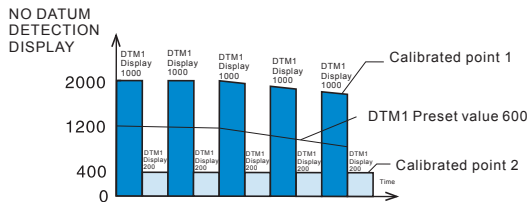

The following sensitivity setting procedure is an example of two point calibration. When there is no workpiece, the intensity of the received light is " 600 ", when there is workpiece, the intensity of light received is " 800 "

Opposite-type and **Reflection-type** are the same

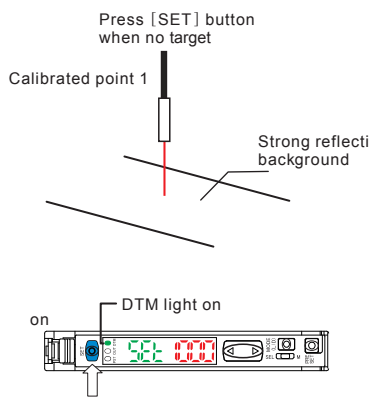

When there is target , press [SET] button

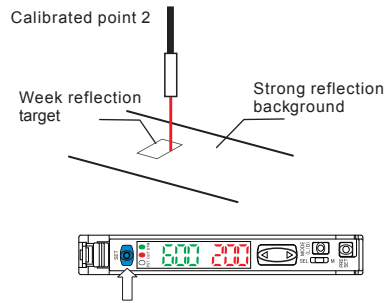

In the state of receiving all light, the intensity of light show " 600 "

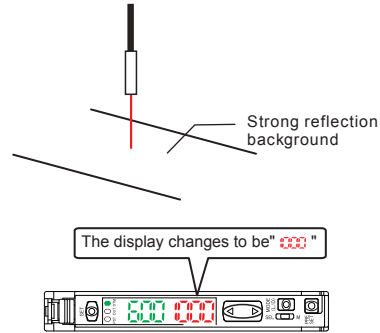

Notice If there is no target, the displayed value is lower than " 600 " and after 30 seconds still does not reach " 600 " , please press the [PRESET] button. This will correct the received light intensity to be " 600 " . When the intensity of the received light stops flashing, the correction is completed.

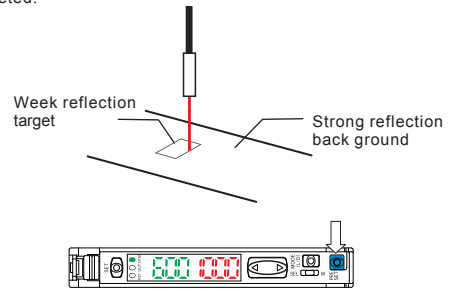

Sensitivity setting in DATUM mode 2- Detect opaque object with Shiny background

The sensitivity pre set value is always automatically corrected, therefore, in case of no, the intensity of light received is " 800 "

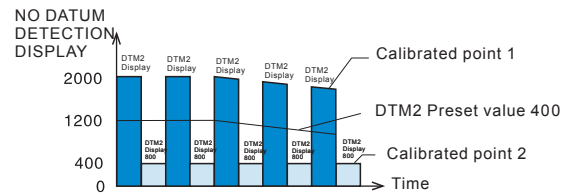

The following sensitivity setting procedure is an example of two point calibration. When there is no workpiece, the intensity of the received light is " 800 ", when there is target, the intensity of light received is " 800 "



Opposite-type and Reflection-type are the same

Press [SET] button without target

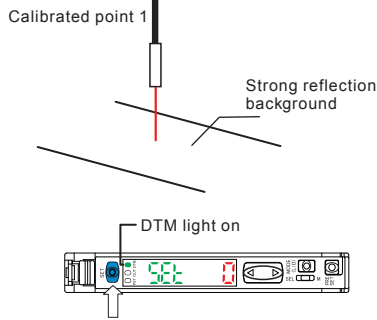

When there is a target, press [SET] button

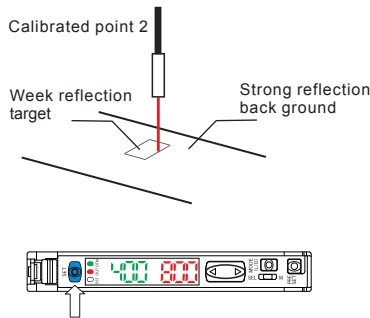

the state of receiving all light, the intensity of light show "0"

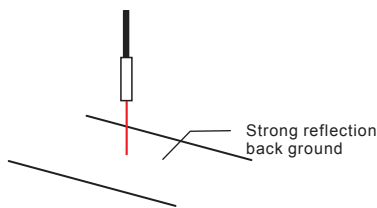

The display change to be "0"



Notice If there is no target, the displayed value is over than "0" and after 30 seconds still does not reach "0", please press the [PRESET] button. This will correct the received light intensity to be "0". When the intensity of the received light stops flashing, the correction is completed.

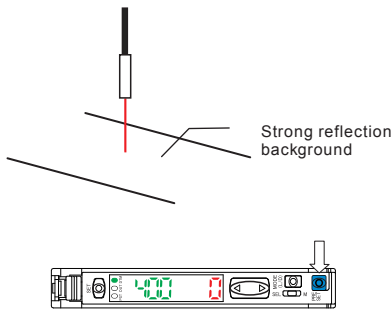

Change the warning output level

DATUM Warning value is the intermediate value of the received light intensity and the preset value when there is no target, if the intensity of the received light is between the warning value and the preset value, the intensity of the received light will stop correcting, and the DTM light will flash to warn.

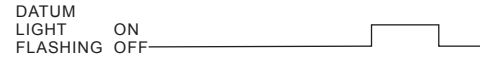
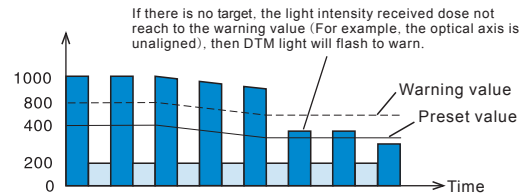

OUTPUT SWITCHING

Optional mode is the action of light entry (L-on) or light shading (D-on)
1. When showing the current value, press the [MODE] button.



2. Use the [MODE] button to switch the output mode (L-on D-on), after that, press [mode] button one more time.
After the switching of out put, the module show the current value.

ERROR DISPLAY AND CORRECTION

Error display	ERC	ERE	END APC	LOC
Reason	Overcurrent exists in the control output	Internal data write/load failure	Light source overload	Keylock
Solution	Detect the load and return the current to the rated rang	Perform initialization	For high precision detection, please replace the sensor	See "LOCK/UNLOCK KEYPAD" in the FY allation manual

INITIALIZATION SETTINGS (FACTORY RESET)

Initialization operation method

1. Press the [SET] button and the [PRESET] button together for 3 seconds

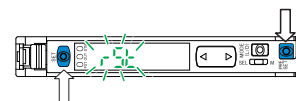

Press on for 3 seconds or longer

- Use the [MODE] button to select "r5t" and then press [MODE] button
- Use the [MODE] button to select "in it" and then press [MODE] button

After the initialization is completed, the module redisplay the current value.

Initial setting

Setting	Initial value
Power mode	FINE
Detection mode	STD (normal)
Preset value	200
Output switching	L-on

LOCK/UNLOCK KEYPAD

To lock/unlock the keypad, press [MODE] together with [MODE] button per 3 seconds.



Micro Detectors
Italian Sensors Technology



WARNING These products are NOT safety sensors and are NOT suitable for use in personnel safety application

Declaration of conformity
M.D. Micro Detectors S.p.A. con Unico Socio declare under our sole responsibility that these products are in conformity with the following EMC directive.

FUNCTION SETTING

Basic setting

Press **MODE** for 3 seconds or longer

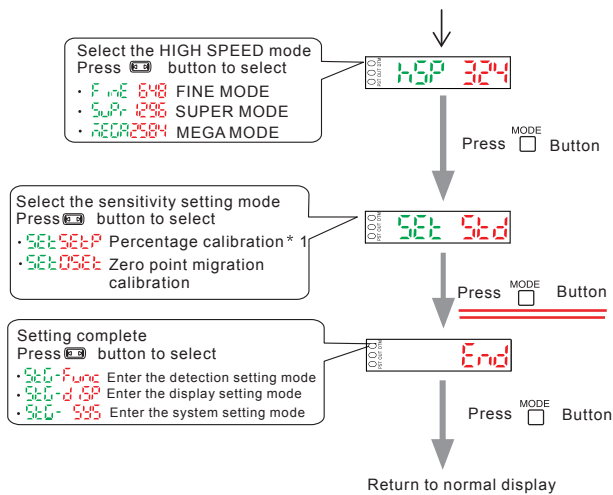

* 1 Press the **MODE** button to set the value range of 99P to -99P

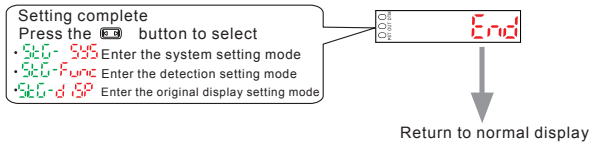

* Press the **MODE** button, set the value in the range from 100P to 200P.

ANTI MUTUAL INTERFERENCE (FY3)

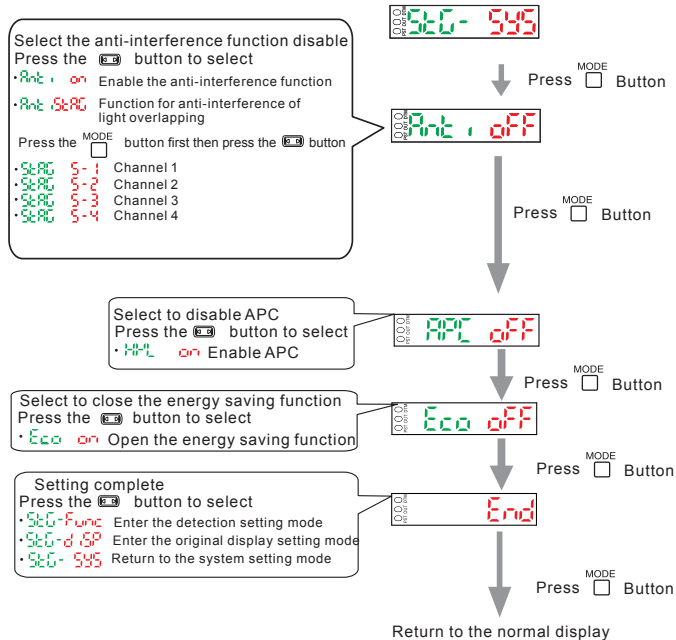

Detection setting

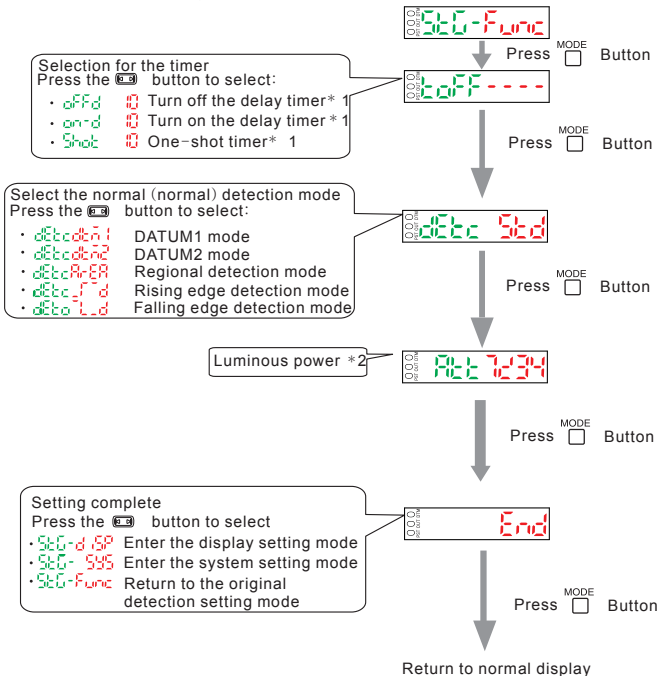

* 1 Press **MODE** button to preset the value rang from 1 to 9999 (ms)

* 2 The value rang can be set from 1 to 100

Display setting

