

Complete documentation available for download at www.datalogic.com



EN Mounting instructions

- mount the encoder on the motor shaft using the reducing sleeve 4 (if supplied). Avoid forcing the encoder shaft;
- fasten the fixing plate 2 to the rear of the motor using two M3 cylindrical head screws 3.
- fix the collar 1 to the encoder shaft (apply threadlocker to screw 1).

IT Istruzioni di montaggio

- inserire l'encoder sull'albero del motore utilizzando la boccola di riduzione 4 (se fornita). Evitare sforzi sull'albero encoder;
- fissare la molla di fissaggio 2 sul retro del motore utilizzando due viti M3 a testa cilindrica 3;
- fissare il collare 1 dell'albero encoder (fissare la vite 1 con frenafiletto).

DE Montagehinweise

- Geber und Reduzierhülse 4 (wenn erforderlich) auf die Motorwelle montieren. Belastungen der Geberwelle vermeiden;
- Befestigungsfeder 2 auf der Rückseite des Motors unter Verwendung zweier M3 Zylinderschrauben 3 montieren;
- Klemmflansch 1 festschrauben (mit geeignetem Klebstoff festigen).

ES Instrucciones de montaje

- montar el encoder y el manguito reductor 4 (si se suministra) en el eje del motor sin forzar el eje del encoder;
- fijar la placa de fijación 2 en la parte posterior del motor mediante los dos tornillos 3 de cabeza cilíndrica tipo M3;
- fijar el collar 1 de el eje encoder (aplicar fijador de roscas).

FR Instructions de montage

- monter le codeur et la douille de réduction 4 (si fournie) sur l'arbre moteur sans forcer l'arbre codeur;
- fixer la plaquette de fixation 2 à la partie postérieure du moteur en utilisant deux vis type M3 à tête cylindrique 3;
- fixer le collier 1 de l'arbre codeur (appliquer du frein-filet sur la vis 1).

MOTOR SHAFT	A [min]	
	min	max
AMT58-H15	8	18

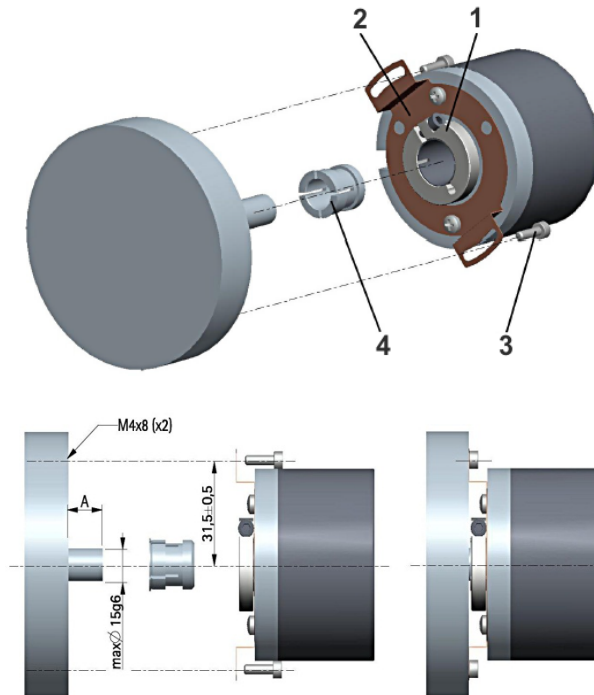

Electrical connection		
Description	Terminal	M12 5-pin
CAN Shield ¹	PG	1 ² , case
+10VDC +30VDC	+	2
0VDC	-	3
CAN GND ³	G	-
CAN HIGH	H	4
CAN LOW	L	5

DeviceNet certificated cables core Ø <1,5mm (0.06")



- 1 Connect the cable shield to cable gland.
- 2 Pin1 connected to shield for earth.
- 3 CAN signals 0V reference, it is not connected to 0VDC supply voltage.

Connector type

frontal side, A coding lato contatti, codifica A Aufsicht Stiftseite A côté contacts, code A

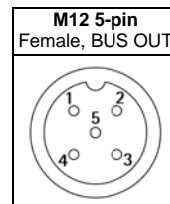
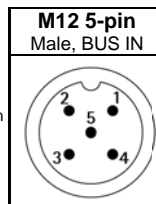

DIP A = BAUD RATE
Default = 0100 = 500Kbit/s

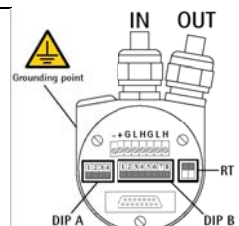
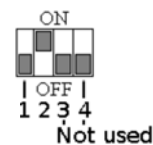

Remove the connection cap to access the terminal connectors and the dip-switches To remove the connection cap loosen the two screws 1. Please be careful with the internal connector. Always replace the connection cap at the end of the operation. Take care in re-connecting the internal connector. Tighten the screws 1 using a tightening torque of approx. 2.5 Nm. Check that the encoder housing and the connection cap are at the same potential before replacing the connection cap!



Installation has to be carried out with power supply disconnected.
L'installazione deve essere eseguita in assenza di tensione.
Der Anschluss darf nur bei ausgeschalteter Versorgungsspannung erfolgen.
La instalación sólo debe ser efectuada en ausencia total de tensión.
Le montage du dispositif doit être effectué en absence totale de tension.

DIP B = NODE-ID
Default = 00000001, binary value

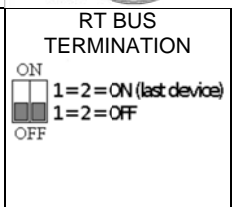
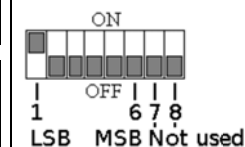

Safety	EN
<ul style="list-style-type: none"> Always adhere to the professional safety and accident prevention regulations applicable to your country during device installation and operation; Installation has to be carried out by qualified personnel only, with power supply disconnected and stationary mechanical parts; the encoder must be used only for the purpose appropriate to its design: use for purposes other than those for which it has been designed could result in serious personal and/or the environment damage; high current, voltage and moving mechanical parts can cause serious or fatal injury; warning ! Do not use in explosive or flammable areas; failure to comply with these precautions or with specific warnings elsewhere in this manual violates safety standards of design, manufacture, and intended use of the equipment; Datalogic assumes no liability for the customer's failure to comply with these requirements. 	

Electrical safety
<ul style="list-style-type: none"> Read carefully the instructions given in the "User's guide" which is an integral part of the device documentation; turn OFF power supply before connecting the device; connect according to explanation in section "Electrical connections"; in compliance with 2014/30/EU norm on electromagnetic compatibility, following precautions must be taken: <ul style="list-style-type: none"> before handling and installing the equipment, discharge electrical charge from your body and tools which may come in touch with the device; power supply must be stabilized without noise: install EMC filters on device power supply if needed; always use shielded cables (twisted pair cables whenever possible); avoid cables runs longer than necessary; avoid running the signal cable near high voltage power cables; mount the device as far as possible from any capacitive or inductive noise source: shield the device from noise source if needed; to guarantee a correct working of the device, avoid using strong magnets on or near by the unit; minimize noise by connecting the shield and/or the connector housing and/or the frame to ground. Make sure that ground is not affected by noise. The connection point to ground can be situated both on the device side and on user's side. The best solution to minimize the interference must be carried out by the user. Provide the ground connection as close as possible to the encoder. We suggest using the ground point provided in the cap, use one TCEI M3 x 6 cylindrical head screw with two tooth lock washers.

Mechanical safety
<ul style="list-style-type: none"> Read carefully the instructions given in the "User's guide" which is an integral part of the device documentation; install the device following strictly the information in the section "Mounting instructions"; mechanical installation has to be carried out with stationary mechanical parts; do not disassemble the device; do not tool the device or its shaft; delicate electronic equipment: handle with care: do not subject the device and the shaft to knocks or shocks; respecting the environmental characteristics of the product.

Sicherheitshinweise	DE
<ul style="list-style-type: none"> Während der Installation und des Betriebes müssen alle allgemeinen, sowie länderspezifischen und anwendungsspezifischen Sicherheitsbestimmungen und Unfallverhütungsvorschriften beachtet werden; das Gerät darf nur bei ausgeschalteter Versorgungsspannung und stehende mechanische Teile von einer Elektrofachkraft eingebaut, angeschlossen und in Betrieb genommen werden; der Einsatz des Gebers ist nur bei bestimmungsgemäßer Verwendung zulässig; hohe Ströme, Spannungen und bewegte mechanische Teile können schwere oder sogar tödliche Verletzungen verursachen; Achtung! Nicht in feuer- oder explosionsgefährdeten Bereichen betreiben; die Nichteinhaltung dieser Vorsichtsmaßnahmen und anderer ausdrücklicher Warnhinweise in diesem Dokument, bedeutet eine Verletzung der Sicherheitsbestimmungen und stellt somit eine nicht bestimmungsgemäße Verwendung dar; Datalogic übernimmt keine Verantwortung für Ausfälle seitens des Kunden, bei Nichteinhaltung dieser Vorschriften. 	

Elektrische Sicherheit
<ul style="list-style-type: none"> Bitte folgen Sie den ausführlich beschriebenen Anweisungen in der "Benutzer Information"; Spannungsversorgung ausschalten bevor das Gerät angeschlossen wird; Verdrahtung gemäß den Vorgaben im Abschnitt, "Electrical connections" vornehmen; in Übereinstimmung mit der Norm 2014/30/EU müssen folgende Vorsichtsmaßnahmen beachtet werden: <ul style="list-style-type: none"> Sichere Entladung aller elektrisch geladenen Teile, die mit dem Gerät bei seiner Handhabung und Installation in Berührung kommen; die Spannungsversorgung muss stabilisiert und geglättet sein. Wenn nötig, müssen zusätzliche EMC-Filter montiert werden; Es dürfen nur geschirmte und möglichst paarig verdrehte Leitungen verwendet werden; unnötig lange Kabel sind zu vermeiden; die parallele Verlegung von Signal- und Leistungskabeln ist zu vermeiden; das Gerät sollte soweit wie möglich von kapazitiven und induktiven Störquellen entfernt montiert werden. Wenn erforderlich, muss das Gerät gegen die Störquellen abgeschirmt werden; um eine störungsfreie Funktion zu gewährleisten, ist der Betrieb in - oder in der Nähe von - starken Magnetfeldern zu vermeiden; Störungen können häufig minimiert werden, indem die Abschirmung des Geberkabels und/bzw. das Steckergehäuse und/bzw. Der Rahmen mit GND verbunden wird. Es muss hierfür sichergestellt sein, dass der GND nicht mit Störungen belastet ist. Ob der Schirm ein- oder beidseitig angelegt wird ist anlagenspezifisch und muss bei der Installation festgelegt werden. Die Bushaube kann ggf. mit einer TCEI M3x6 Schraube an einen Massepunkt angeschlossen werden. Die Verbindung sollte so kurz wie möglich sein.

Mechanische Sicherheit
<ul style="list-style-type: none"> Bitte folgen Sie den ausführlich beschriebenen Anweisungen in der "Benutzer Information"; der Einbau des Gerätes muss unter strikter Beachtung des Kapitels, "Montagehinweise" erfolgen; das Gerät darf nur bei stehende mechanische Teile eingebaut werden; der Geber darf nicht zerlegt werden; der Geber und seine Welle dürfen nicht bearbeitet werden; empfindlich elektronisch Gerät: pfleglich zu behandeln; Geber und Welle dürfen keinen Stößen oder Schlägen ausgesetzt werden; die produktspezifischen Umgebungsbedingungen müssen beachtet werden.

Mesures de sécurité	FR
<ul style="list-style-type: none"> Pendant l'installation et l'utilisation du dispositif veuillez observer les réglementations préventives en matière de sécurité et d'accident en vigueur dans votre pays; le montage du dispositif doit être pris en charge par un spécialiste ayant des connaissances en électricité et en mécanique: avant d'installer le dispositif s'assurer qu'il y a absence de tension et composants mécaniques à l'arrêr; il est défendu d'utiliser le dispositif en manière pas conforme à l'usage prévu par le constructeur: toute utilisation différente pourrait engendrer des risques sérieux pour les personnes et/ou l'environnement; hautes tensions, voltages élevés et composants en mouvement peuvent engendrer des risques sérieux ou fatals pour les personnes; il est défendu d'utiliser le dispositif dans un milieu explosif; la non-observance des normes de sécurité ou bien des avertissements spécifiés dans ce manuel sera considérée une violation des normes de sécurité fondamentales prévues par le constructeur ou bien requêtes pour l'usage prévu du dispositif; la Société Datalogic nie toute responsabilité pour tout dommage ou blessure que l'utilisateur peut encourir à la suite de la non-observance des normes de sécurité. 	

Précautions électriques
<ul style="list-style-type: none"> Lire attentivement les instructions contenues dans le « Manuel de l'utilisateur » qui fait partie intégrante de la documentation de l'appareil ; il est absolument défendu d'effectuer les connexions électriques lorsque le système est sous tension; respecter les instructions de connexion mentionnées dans la section « Electrical connections »; en conformité avec la norme 2014/30/EU concernant la compatibilité électromagnétique respecter les précautions suivantes: <ul style="list-style-type: none"> avant de manipuler ou bien installer le dispositif, éliminer la charge électrostatique présente au niveau du corps de l'utilisateur ou bien des outils qui seront en contact avec le dispositif; relier le dispositif au réseau électrique en s'assurant qu'il soit stabilisé et absent de dérangements: s'il s'avère nécessaire, installer des filtres EMC à l'entrée du réseau d'alimentation; toujours utiliser des câbles blindés et, si possible, torsadés; ne pas utiliser des câbles plus longs que le nécessaire; s'assurer que le câble qui porte les signaux du dispositif ne soit pas placé à côté ou bien en proximité des câbles de puissance; installer le dispositif loin des composants qui peuvent causer des dérangements ou bien le blindé soigneusement; afin de garantir un fonctionnement correct de l'appareil on conseille de n'utiliser pas des équipements possédants une forte charge électromagnétique en proximité de l'unité; connecter le blindage du câble et/ou la protection du connecteur et/ou le corps du dispositif à la borne de la mise à terre: s'assurer que la borne de la mise à terre soit absente de dérangements. Le raccordement de la borne de la mise à terre peut être effectué sur le côté codeur et/ou sur le côté utilisateur: l'utilisateur est chargé de mieux évaluer la solution meilleure afin de éliminer ou minimiser les dérangements. Revenir à la terre au plus proche du codeur. On conseille d'utiliser le point de connexion pourvu sur le couvercle du dispositif, au moyen d'une vis à tête cylindrique type TCEI M3 x 6 et deux rondelles autobloquantes.

Précautions mécaniques
<ul style="list-style-type: none"> Lire attentivement les instructions contenues dans le « Manuel de l'utilisateur » qui fait partie intégrante de la documentation de l'appareil ; installer le dispositif en respectant soigneusement les instructions de montage dans la section « Instructions de montage »; le montage mécanique du dispositif doit être effectué avec composants mécaniques à l'arrêr; ne démonter pas le dispositif ni exécuter des usinages sur le dispositif; dispositif électronique fragile: manipuler avec soin: éviter tout coup et sollicitation qui peuvent endommager l'arbre et le corps; utiliser le dispositif tout en respectant les caractéristiques environnementales mentionnées par le constructeur.

Avvertenze	IT
<ul style="list-style-type: none"> Durante l'installazione e l'utilizzo del dispositivo osservare le norme di prevenzione e sicurezza sul lavoro previste nel proprio paese; l'installazione deve essere eseguita da personale qualificato, in assenza di tensione e parti meccaniche in movimento; utilizzare il dispositivo esclusivamente per la funzione per cui è stato costruito: ogni altro utilizzo potrebbe risultare pericoloso per l'utilizzatore; alte correnti, tensioni e parti meccaniche in movimento possono causare lesioni serie o fatali; non utilizzare in ambienti esplosivi o infiammabili; il mancato rispetto delle norme di sicurezza o delle avvertenze specificate in questo manuale è considerato una violazione delle norme di sicurezza standard previste dal costruttore o richieste dall'uso per cui lo strumento è destinato; Datalogic non si assume alcuna responsabilità per eventuali danni o lesioni derivanti dall'inosservanza delle norme di sicurezza da parte dell'utilizzatore. 	

Avvertenze elettriche
<ul style="list-style-type: none"> Leggere attentamente le istruzioni riportate nel "Manuale d'uso" che è parte integrante della documentazione del dispositivo; effettuare le connessioni elettriche esclusivamente in assenza di tensione; rispettare le connessioni riportate nella sezione "Electrical connections"; in conformità alla normativa 2014/30/EU sulla compatibilità elettromagnetica rispettare le seguenti precauzioni: <ul style="list-style-type: none"> prima di maneggiare e installare il dispositivo, eliminare la presenza di carica elettrostatica dal proprio corpo e dagli utensili che verranno in contatto con il dispositivo; alimentare il dispositivo con tensione stabilizzata e priva di disturbi, se necessario, installare appositi filtri EMC all'ingresso dell'alimentazione; utilizzare sempre cavi schermati e possibilmente "twistati"; non usare cavi più lunghi del necessario; evitare di far passare il cavo dei segnali del dispositivo vicino a cavi di potenza; installare il dispositivo il più lontano possibile da eventuali fonti di interferenza o schermarlo in maniera efficace; per garantire un funzionamento corretto del dispositivo, evitare l'utilizzo di apparecchiature con forte carica magnetica in prossimità dell'unità; collegare la calza del cavo e/o la custodia del connettore e/o il corpo del dispositivo a un buon punto di terra: assicurarsi che il punto di terra sia privo di disturbi. Il collegamento a terra può essere effettuato sul lato dispositivo e/o sul lato utilizzatore; è compito dell'utilizzatore valutare la soluzione migliore da adottare per minimizzare i disturbi. Effettuare il collegamento a terra il più vicino possibile all'encoder. Per la messa a terra si consiglia di utilizzare il punto di collegamento previsto sul coperchio del dispositivo, utilizzare una vite TCEI M3 x 6 a testa cilindrica con due rondelle zigrinate.

Avvertenze meccaniche
<ul style="list-style-type: none"> Leggere attentamente le istruzioni riportate nel "Manuale d'uso" che è parte integrante della documentazione del dispositivo; montare il dispositivo rispettando rigorosamente le istruzioni riportate nella sezione "Istruzioni di montaggio"; effettuare il montaggio meccanico esclusivamente in assenza di parti meccaniche in movimento; non disassemblare il dispositivo; non eseguire lavorazioni meccaniche sul dispositivo; dispositivo elettronico delicato: maneggiare con cura: evitare urti o forti sollecitazioni sia all'albero che al corpo del dispositivo; utilizzare il dispositivo in accordo con le caratteristiche ambientali dello stesso.

Seguridad	ES
<ul style="list-style-type: none"> Durante la instalación y uso del dispositivo observar las normas de prevención de riesgos y seguridad laboral vigentes en el país; la instalación solo debe ser efectuada por personal cualificado, en ausencia total de tensión y con el eje inmóvil; utilizar el dispositivo exclusivamente para la función para la que ha sido construido: cada uso diferente puede resultar peligroso para el usuario; altas corrientes, voltajes y componentes mecánicos en movimiento pueden causar lesiones serias o incluso fatales; atención: no utilice el dispositivo en lugares inflamables y explosivos; la inobservancia de las normas de seguridad y de las advertencias mencionadas en este manual resulta en la violación de las normas básicas de seguridad y salud previstas por el constructor o requeridas por la función para la que el dispositivo ha sido construido; Datalogic no asume responsabilidad por eventuales daños, perjuicios o lesiones que pueden derivarse de la inobservancia de las normas de seguridad por el usuario. 	

Seguridad eléctrica
<ul style="list-style-type: none"> Lea cuidadosamente las instrucciones detalladas en el "Manual del usuario" que forma parte integral de la documentación del dispositivo; efectuar la conexión eléctrica exclusivamente en ausencia de tensión; respetar las conexiones según se indican en la tabla "Electrical connections"; en conformidad con la norma 2014/30/EU sobre la compatibilidad electromagnética se deben respetar las siguientes precauciones: <ul style="list-style-type: none"> antes de manejar e instalar el dispositivo, elimine cualquier carga electrostática de su propio cuerpo y de las herramientas que entrarán en contacto con el dispositivo; alimente el dispositivo con tensión estabilizada y libre de ruido: de ser necesario, instale filtros EMC en la entrada de la alimentación; utilice cables apantallados y trenzados siempre que sea posible; no use cables más largos de lo necesario; evite pasar el cable de señal del dispositivo cerca de los cables de potencia; instale el dispositivo lo más lejos posible de potenciales fuentes de interferencia, o apantallelo de forma eficaz; para garantizar el correcto funcionamiento del dispositivo, evitar el uso de instrumentos que tienen carga eléctrica intensa cerca de la unidad; conecte la malla del cable y/o la carcasa del conector y/o el cuerpo del dispositivo a una buena toma de tierra: asegúrese de que la toma de tierra esté libre de ruido. La conexión a tierra puede efectuarse en el lado encoder y/o en el lado usuario, es el usuario quien ha de valorar la mejor solución a adoptar para minimizar el ruido. La conexión a tierra debe efectuarse tan cerca como sea posible de l'encoder. Aconsejamos utilizar el punto de conexión en la tapa del dispositivo por medio de un tornillo con cabeza cilíndrica tipo TCEI M3 x 6 y dos arandelas autoblocantes.

Seguridad mecánica
<ul style="list-style-type: none"> Lea cuidadosamente las instrucciones detalladas en el "Manual del usuario" que forma parte integral de la documentación del dispositivo; montar el dispositivo, tal como se indica en la sección "Instrucciones de montaje"; la instalación mecánica solo debe ser efectuada con componentes mecánicos inmóviles; no desensamblar el dispositivo; no realizar trabajos mecánicos sobre el dispositivo o el eje; dispositivo electrónico delicado: manejar con cuidado: evitar golpes tanto sobre el eje como sobre el cuerpo del dispositivo; utilizar el dispositivo respetando sus características ambientales.

	<p>This device is to be supplied by a Class 2 Circuit or Low-Voltage Limited Energy or Energy Source not exceeding 30 VDC. Refer to the ordering code for supply voltage rate.</p>
--	--

Datalogic S.r.l.
Via S. Vitalino 13 - 40012 Calderara di Reno - Italy
Tel: +39 051 3147011 - Fax: +39 051 3147205 - www.datalogic.com

Helpful links at www.datalogic.com: **Contact Us, Terms and Conditions, Support.**

The warranty period for this product is 24 months. See General Terms and Conditions of Sales for further details.

	<p>Under current Italian and European laws, Datalogic is not obliged to take care of product disposal at the end of its life. Datalogic recommends disposing of the product in compliance with local laws or contacting authorised waste collection centres.</p>
---	--

© 2014 - 2017 Datalogic S.p.A. and/or its affiliates • ALL RIGHTS RESERVED. • Without limiting the rights under copyright, no part of this documentation may be reproduced, stored in or introduced into a retrieval system, or transmitted in any form or by any means, or for any purpose, without the express written permission of Datalogic S.p.A. and/or its affiliates. Datalogic and the Datalogic logo are registered trademarks of Datalogic S.p.A. in many countries, including the U.S.A. and the E.U. All other trademarks and brands are property of their respective owners. Datalogic reserves the right to make modifications and improvements without prior notification.